

Model Specific

Dedicated accessories for Livestock • Horsebox • Box Van • Commercial Trailers



Horsebox	Page
Tack pack removable tack storage unit and horsebox side decals	55
Ramp & door fittings for most horsebox models	56
Rear door kits (to upgrade basic models) & rear door fittings	57
Centre partitions, breeching bars and partition components HB505	58
Centre partitions, breeching bars and partition components HB510	59
Breeching bars for HB401 single horsebox and for some older models	60
Aluminium floor kits, floor matting, edging & kickboard panels	61
Two post partition spares & side panel material for older models	62
Internal padding material and padding retainer bars	63
Livestock	Page
Horse partition kits for TA5 & 510 models with 7' headroom	64
Horse partitions and spares for the larger horseboxes, HB510XL & HB610	65
Hardware, spring bolts, back rails & Easyload™ ramp spares	66
Small cross divisions and cross division gates for trailers with decks	67
Large cross divisions for trailers without decks or with decks folded away	68

Livestock	Page
Division parts and mounting accessories for large or small cross divisions	69
Cross divisions for single height livestock trailers P6G, P8G, TA5 (4') and P6e	70
Deck kits, components and support bars for the older livestock models	71
Deck kits, components and support bars for the current livestock models	72
Ramp gates & ramp gate extensions, mounting brackets and their hinge pins	73
Sump tank kits and sealed floor components, cross divisions for sealed floor trailers	74
Commercial	Page
Dropside kits, individual dropsides, pillars and components for LT/LM models	75
Meshside kits, individual panels, extended pillars and fixings for LT/LM models	76
Meshside kits, individual panels, pillars and fixings for GD, GX & P6e models	77
Meshside kits, individual panels, extended pillars and fixings for tipper models	78
Headboards, tailboards & ladder racks for most commercial models	79
High ramps for the LT/LM range, GD & P6e ramps & ramp parts	80
Ladder racks, mesh sides, aluminium floors and kits for metric GD Models	81

Unbraked	Page
Meshsides, tarpaulins, ladder racks and kits for the unbraked P6e & P7e models	82
Roofrack & floor covering for the BV64e boxvan meshsides, tarpaulin & kits for the P5	83
Car Transporter	Page
Winches, centre decking, loading skids and ski-jump kit for the CT177	84
Winches, tyre racks, toolbox, skids and motorcycle recovery kit for the CT136	85
Box Van	Page
Replacement roller shutter, door locks and handles for the box van range	86
Eurolight	Page
Dropside kits, meshsides, aluminium floors and kits for Eurolight range trailers	87
Tipper	Page
Hydraulic hand pumps and spares, cylinders, hoses, seal kits, and hydraulic fluid	88
Hydraulic power pack, remote control unit, electrical and hydraulic spares	89
Canopies	Page
Tailgates, fixings and door handles for pick-up and trailer canopies	90

Model Specific

Horsebox Decals & Tack Pack



HB510 fitted with C704711 Silver Decals

	C704611 Horsebox Decals (Silver). For HB401 & HB505.	£29.38
1	C704618 Horsebox Decals (Black). For HB401 & HB505.	£29.38
	C704711 Horsebox Decals (Silver). For HB510.	£29.38
	C704718 Horsebox Decals (Black). For HB510.	£29.38
2	P04468 Tack pack (black). Removable storage unit for your HB5 or 6 series horsebox trailer, includes galvanized saddle rack, removable feed bowl and lockable front fasteners.	£223.25
	P04464 Tack pack (red). specification as above.	£223.25
	P04466 Tack pack (blue). specification as above.	£223.25
	P04463 Tack pack (green). specification as above.	£223.25
3	P0448 Tack pack wheel. Replacement wheel for tack pack units.	£10.10
4	P0449 Axle. Replacement axle to fit the tack pack unit.	£6.15
5	B0102A Elastic strap. 32" long.	£1.25
	B0102B Elastic strap. 36" long.	£1.50
	B0102C Elastic strap. 42" long.	£1.75

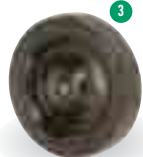

To Order – See pages 4 & 5 for distributor contact details or call direct on 0945 4082 505

To Order – See pages 4 & 5 for distributor contact details or call direct on 0845 4082 505



	KS3026	Front door. HB505 Complete front upper door kit (white).	£67.55
1	KS3027	Front door. HB510 Complete front upper door kit (white).	£76.40
	KS3022	Front door. HB510 Complete front upper door kit (stucco aluminium).	£70.50
	KS3021	Front door. HB505 Complete front upper door kit (stucco aluminium).	£52.90
	C40532	Door panel. HB505 - The aluminium panel for the door over the front ramp.	£29.40
	C40531	Door panel. HB510 - The aluminium panel for the door over the front ramp.	£29.40
	C40539	Door panel. HB401 - The aluminium panel for the door over the front ramp.	£27.05
	C40538	Overdoor panel. Aluminium panel that fits over the inspection door on the HB401.	£28.40
2	C1114SS	Door pull. Combined antiluce plate and door pull for door over front ramp (Stainless Steel).	£4.40
3	C11154	Hinge. Cranked hinge used on the door over the side ramp (Stainless Steel).	£9.10
4	P1300	Door seal. Horsebox rigid double lipped door seal 1036mm long.	£4.50
4	P1301	Door seal. Horsebox rigid double lipped door seal 1185mm long.	£5.50
5	P1228	Ramp guide. Allows the ramp to sit correctly in its aperture and prevents sideways movement.	£1.75
6	P1247	Ramp guide. Similar to P1228 but with no back stop.	£2.35
	AS4108	Ramp hinge. Front bolt on ramp hinge for HB401, 505 & 510.	£6.90
7	P1246	Ramp pivot bush. Used on the ramp and chassis hinge points.	£1.20
8	P1194	End cap. For the ramp latch handles on front & rear ramps of HB401, 505 & 510 models.	£0.60
9	P11190	Pin & chain. For the front and rear ramp latches.	£2.35
10	P1191	Gas spring. For the front ramp on HB401, 505 & 510 models.	£29.40
11	P1192	Bellows. Front ramp gas spring bellows for HB401, 505 & 510 (From 1992).	£5.90
12	C00150	Staple. 50mm long ramp catch staple. (Front ramp).	£1.20
13	C00151	Staple. 75mm long ramp catch staple. (Rear ramp).	£1.20
14	P1004	Antiluce fastner. Used on current horsebox models.	£2.35
15	P1010G	Antiluce. Used on HB306 front ramp and horsebox containers.	£2.35
16	C10617SS	Door pull. Combined antiluce plate and door pull used on horsebox inspection doors (Stainless Steel).	£4.10
17	P1072SS	Hinge. Inspection door hinge for horsebox models HB401, 505 & 510 (Stainless Steel).	£2.80



Model Specific

Horsebox Rear Doors



1	KS3001 Rear doors. A pair of rear doors to fit the HB505 (kit includes hinges and retainer plates).	£117.50
	KS3004 Rear doors. A pair of rear doors to fit the HB510 (kit includes hinges and retainer plates).	£117.50
	KS3006 Rear doors. A pair of rear doors to fit the HB401 (kit includes hinges and retainer plates).	£117.50
2	C00833 Retainer plate RH. For Horsebox models HB401, 505 & 510 holds rear doors (above ramp) against lynch pin receivers.	£5.50
3	C00834 Retainer plate LH. For Horsebox models HB401, 505 & 510 holds rear doors (above ramp) against lynch pin receivers.	£5.50
4	P1110/50SS Lynch pin. 1/4" shaft diameter 50mm long stainless steel.	£1.20
5	C11155 Hinge. Rear door hinge for Horsebox models HB401, 505 & 510 (Stainless Steel).	£9.10
6	P1311 Edge beading. Black with steel insert. (Per metre).	£2.40
7	AS0630SS Lynch pin receiver. Used for holding rear doors in the open position (Stainless Steel).	£4.70
8	P1330/30 Neoprene tube. This small tube is fitted to the outer door retainers to act as a buffer for the antiluce plate.	£0.25
9	P1111 Lynch pin receiver. Weld on replacement, used to secure rear doors to horsebox ramp.	£1.20

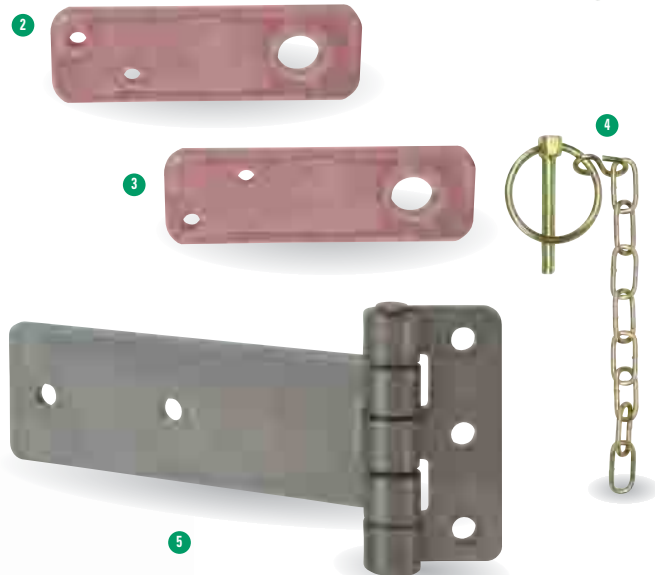

To Order – See pages 4 & 5 for distributor contact details or call direct on 0845 4082 505



HB 401single horsebox

These new grey partitions can also be used to replace the coloured partitions in trailers manufactured since January 1999, both types are fully interchangeable with the head partitions.

Model Specific Horsebox Centre Partition

HB505



1	KX0079	Head partition. For HB505.	£47.00
2	C00130	Pin. Retainer pin for head partitions (From 1999).	£2.40
	P1150	Ring. 38mm Split ring.	£0.60
3	KS30481	Partition leaf. HB505 Front leaf.	£82.25
4	KS30461	Partition leaf. HB505 Front leaf.	£82.25
5	C82543	Partition skirt. HB505 for front or rear use.	£17.05
6	C72549	Corner. Joins together the extruded sections of the centre partition.	£0.30
7	P1021	Retainer hook. Used to hold the centre partition open whilst loading.	£1.70
8	P1022	Mini tie. Soft rubber version used on horsebox head partitions or for general holding and tie back applications. (135mm centres)	£1.20
9	P1025	Mini tie. Longer version with 225mm centres.	£1.40
10	AS7585	Centre pillar. HB505 - the type used since January 1999.	£47.00
11	AS7459	Fixing bracket. HB505 - Fixes the centre partition pole to the trailer roof.	£13.65
12	C11153	Fixing bracket. Used where centre partition pole enters the floor.	£4.70
13	C00077	Clevis pin. Used to secure the centre partition pole to the upper bracket (HB505/510 or TA5 models with horse kit).	£1.75
14	F1913Z	R clip. Holds the centre partition clevis securely in place.	£0.30
15	P1110	Linch pin. 1/4 inch diameter linch pin and snap ring with retainer chain fitted (50mm pin). Stainless steel.	£1.20
	KS2695	Breast/Breeching bar. HB505 plain aluminium type.	£17.05
16	KS26968	Breast/Breeching bar. HB505 plastic covered (Black).	£19.75
17	KX01158	Breast/Breeching bar full length. HB505 plastic covered (Black).	£41.13
18	C31253	Pin end. Pin end casting for breast/breeching bars.	£5.90
19	C31252	Hook end. Hook end casting for breast/breeching bars.	£5.90
20	C31259	Pin end (sliding). Pin end casting for full width bars.	£8.80
21	C31250	Receiver bracket. Three hole cast receiver bracket.	£6.45
22	F0925ZPK	Socket screw. M8x50 CAP head.	Pack 10 £2.35
23	F1003ZPK	Nut. M8 Plain hex type.	Pack 20 £2.35

24	F0932MAPK	Socket screw. This M8x35 button head screw retains the breast/breeching bar receiver bracket from the outside of the trailer (Red).	Pack 16 £8.80
	F0932GRP	Socket screw. Green.	Pack 16 £8.80
	F0932BLPK	Socket screw. Blue.	Pack 16 £8.80
	F0932WHPK	Socket screw. White.	Pack 16 £8.80
	F0932SLPK	Socket screw. Silver.	Pack 16 £8.80
	F0932BKPK	Socket screw. Black.	Pack 16 £8.80
25	F1103MAPK	Retainer washer. This washer sits under the breast/breeching bar receiver bolt on the outside of the trailer (Red).	Pack 16 £5.30
	F1103GRP	Retainer washer. Green.	Pack 16 £5.30
	F1103BLPK	Retainer washer. Blue.	Pack 16 £5.30
	F1103WHPK	Retainer washer. White.	Pack 16 £5.30
	F1103SLPK	Retainer washer. Silver.	Pack 16 £5.30
	F1103BKPK	Retainer washer. Black.	Pack 16 £5.30
26	P1278PK	Neoprene washer. 40mm washer used under the breast/breeching bar retainer washers.	Pack 16 £3.55
27	P1260	Hex key. For the Horsebox breast/breeching bar release system on HB401, 505 & 510.	£1.20
28	P13294/8	Breast/breeching bar cover. 705mm cover (Black).	£8.25
29	C498870	Breast/breeching bar tube. 698.0mm aluminium section.	£6.80

Model Specific

Horsebox Centre Partition

These new grey partitions can also be used to replace the coloured partitions in trailers manufactured since January 1999, both types are fully interchangeable with the head partitions.

Ifor Williams
Parts®

Page
59

HB510



1	KX0080	Head partition. For HB510.	£52.88
2	C00130	Pin. Retainer pin for head partitions (From 1999).	£2.40
	P1150	Ring. 38mm Split ring.	£0.60
3	KS30471	Partition leaf. HB510 Front leaf.	£82.25
4	KS30451	Partition leaf. HB510 Front leaf.	£82.25
5	C82544	Partition skirt. HB510 for front or rear use.	£17.05
6	C72549	Corner. Joins together the extruded sections of the centre partition.	£0.30
7	P1021	Retainer hook. Used to hold the centre partition open whilst loading.	£1.70
8	P1022	Mini tye. Soft rubber used on horsebox head partitions or for general holding and tie back. 135mm centres.	£1.20
9	P1025	Mini tye. Longer version. 225mm centres.	£1.40
10	AS7590	Centre pillar. HB510 - the type used from January 1999.	£58.75
11	AS7509	Fixing bracket. HB510 - Fixes the centre partition pole to the trailer roof.	£13.65
12	C11153	Fixing bracket. Used where centre partition pole enters the floor.	£4.70
13	C00077	Clevis pin. Used to secure the centre partition pole to the upper bracket (HB505/510 or TA5 models with horse kit).	£1.75
14	F1913Z	R clip. Holds the centre partition clevis securely in place.	£0.30
15	P1110	Lynch pin. 1/4 inch diameter lynch pin and snap ring with retainer chain fitted (50mm pin). Stainless steel.	£1.20
	KX2720	Breast/breeching bar. HB505 plain aluminium type.	£17.05
16	KS27218	Breast/breeching bar. For HB510 (Black).	£19.75
17	KX01168	Breast/breeching bar full length. For HB510 (Black).	£41.13
18	C31253	Pin end. Pin end casting for breast/breeching bars.	£5.90
19	C31252	Hook end. Hook end casting for breast/breeching bars.	£5.90
20	C31259	Pin end (sliding). Pin end casting for full width breeching bars.	£8.80
21	C31250	Receiver bracket. Three hole breeching bar receiver bracket.	£6.45
22	F0925ZPK	Socket screw. M8x50 CAP head.	Pack 10 £2.35
23	F1003ZPK	Nut. M8 Plain hex type.	Pack 20 £2.35

24	F0932MAPK	Socket screw. This M8x35 button head screw retains the breast/breeching bar receiver bracket from the outside of the trailer (Red).	Pack 16 £8.80
	F0932GRPK	Socket screw. Green.	Pack 16 £8.80
	F0932BLPK	Socket screw. Blue.	Pack 16 £8.80
	F0932WHPK	Socket screw. White.	Pack 16 £8.80
	F0932SLPK	Socket screw. Silver.	Pack 16 £8.80
	F0932BKPK	Socket screw. Black.	Pack 16 £8.80
25	F1103MAPK	Retainer washer. This washer sits under the breast/breeching bar receiver bolt on the outside of the trailer (Red).	Pack 16 £5.30
	F1103GRPK	Retainer washer. Green.	Pack 16 £5.30
	F1103BLPK	Retainer washer. Blue.	Pack 16 £5.30
	F1103WHPK	Retainer washer. White.	Pack 16 £5.30
	F1103SLPK	Retainer washer. Silver.	Pack 16 £5.30
	F1103BKPK	Retainer washer. Black.	Pack 16 £5.30
26	P1278PK	Neoprene washer. 40mm washer used under the breast/breeching bar retainer washers.	Pack 16 £3.55
27	P1260	Hex key. For the Horsebox breast/breeching bar release system on HB401, 505 & 510.	£1.20
28	P13292/8	Breast/breeching bar cover. 766mm cover for breast/breeching bars (Black).	£8.25
29	C498860	Breast/breeching bar tube. For HB510.	£7.85

To Order – See pages 4 & 5 for distributor contact details or call direct on 0845 4082 505

To Order - See pages 4 & 5 for distributor contact details or call direct on 0845 4082 505



1	KS26858 Breeching bar. HB401.	£25.60
2	P13296/8 Breeching bar cover. HB401.	£9.40
3	C49885 Breeching bar tube. HB401.	£11.05





HB505 double horsebox

KICKBOARD PANELS

1	C79012	Kickboard. RH Kickboard for HB401/505R (1992 - 1999).	£31.75
	C79015	Kickboard. LH Kickboard for HB510 (1999 on).	£30.10
	C79016	Kickboard. RH Kickboard for HB510 (1999 on).	£30.10
	C79018	Kickboard. LH Kickboard for HB505 (1999 on).	£24.90
	C79019	Kickboard. RH Kickboard for HB505 (1999 on).	£24.90

FLOOR & REAR RAMP MATTING

	C80810	Floor Matting. Ribbed rubber matting pre cut to fit HB401.	£173.90
2	C80812	Floor Matting. Ribbed rubber matting pre cut to fit HB505 Basic (No front ramp).	£217.40
	C80814	Floor Matting. Ribbed rubber matting pre cut to fit HB505 (Post 1992).	£217.40
	C80816	Floor Matting. Ribbed rubber matting pre cut to fit HB510.	£269.10
	C89031	Floor Matting. 10mm patterned rubber matting 2000mm x 1000mm.	£55.25
	C80773	Floor Matting Section. Front section floor matting for HB505R Basic (no front ramp).	£45.85
3	C890454	Ramp Matting. High grip rubber matting pre cut to fit HB505 Rear ramp.	£65.80
	C890455	Ramp Matting. High grip rubber matting pre cut to fit HB510 Rear ramp.	£70.50

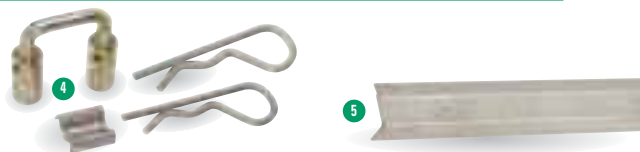

4	KS27230	Floor mat fixing - set of 4. Staples with fixing hardware.	£11.75
	C49781	Corner moulding. 990mm corner moulding.	£8.25
5	C49765	Corner moulding. 1150mm corner moulding.	£9.40
	C49772	Corner moulding. 1473mm corner moulding.	£11.15
	C49769	Corner moulding. 1513mm corner moulding.	£11.15
	C49763	Corner moulding. 1524mm corner moulding.	£11.15
	C497635	Corner moulding. 1524mm square corner moulding.	£11.15
	C49779	Corner moulding. 1620mm corner moulding.	£11.15

FRONT RAMP MATTING

6	C890451	Ramp Matting. High grip rubber matting pre cut to fit HB401/505 Front ramp.	£44.65
	C890453	Ramp Matting. High grip rubber matting pre cut to fit HB510 Front ramp.	£50.55
	C890461	Ramp Matting. High grip rubber matting for horsebox container front ramp 1420 x 1140 x 6mm.	£126.90
	C890460	Matting. Container ramp matting (6mm) 2050 x 1770.	£200.95

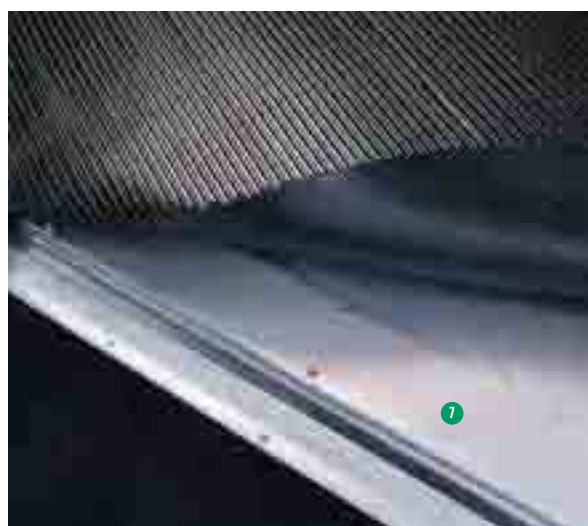

ALUMINIUM FLOOR KITS









7	KS0700	Aluminium Floor Kit. Pre formed aluminium floor and finsher strips, to fit HB505 (Pre 1992).	£270.25
	KS0705	Aluminium Floor Kit. Pre formed aluminium floor and finsher strips, to fit HB410.	£211.50
	KS0711	Aluminium Floor Kit. Pre formed aluminium floor and finsher strips, to fit HB505 (Post 1992).	£270.25
	KS0714	Aluminium Floor Kit. Pre formed aluminium floor and finsher strips, to fit HB505 Basic (No front ramp).	£270.25
	KS0720	Aluminium Floor Kit. Pre formed aluminium floor and finsher strips, to fit HB510.	£317.25

To Order – See pages 4 & 5 for distributor contact details or call direct on 0845 4082 505



HB401 single horsebox

SIDE PANEL MATERIAL

	C69306 12mm Side panel. 604mm x 1434mm grey/grey phenolic coated smooth plywood side panel. £37.60
	C69307 12mm Side panel. 604mm x 1525mm grey/grey phenolic coated smooth plywood side panel. £45.85
	C69324 12mm Side panel. 1525mm x 1072mm grey/grey phenolic coated smooth plywood side panel. £58.55
	C69116B 12mm Side panel. 1525mm x 2073mm brown/brown phenolic coated smooth plywood side panel. £168.05
	C69316 12mm Side panel. 1525mm x 2073mm grey/grey phenolic coated smooth plywood side panel. £168.05
	C69276 12mm Side panel. 1525mm x 2073mm grey/white phenolic coated smooth plywood side panel. £168.05
	C69305 12mm Side panel. 1525mm x 2292mm grey/grey phenolic coated smooth plywood side panel. £252.65
	C69108B 12mm Side panel. 1525mm x 445mm brown/brown phenolic coated smooth plywood side panel. £25.40
	C69308 12mm Side panel. 1525mm x 445mm grey/grey phenolic coated smooth plywood side panel. £58.55



PARTITION SKIRT MATERIAL

C89004 Partition skirt material. 1645mm x 730mm x 4.5mm. £34.65
C89023 Partition skirt material. 910mm x 730mm x 4.5mm. £21.75
C89024 Partition skirt material. 810mm x 730mm x 4.5mm. £21.75

PARTS FOR STEEL-FRAMED AND TWO-POST PARTITIONS

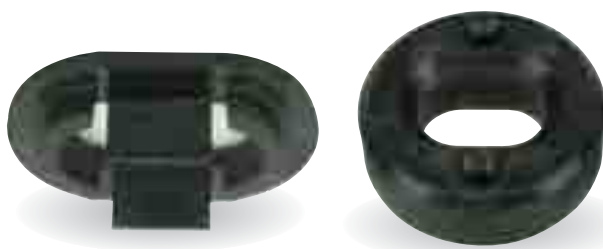

P1224 Snap fit bush. Used in grey steel framed partitions in horsebox HB401, 505 & 510. £0.60
C11134 Locating plate. Lower mounting for centre partition pole, fixes over slot in trailer floor. £3.55
AS4293 Head partition. HB505R 1989-1992 (galvanized steel). £47.00
AS4294 Head partition. HB505R 1992-1999 (galvanized steel). £52.90
AS4295 Head partition. HB510R 1992-1999 (galvanized steel). £58.75
AS2800 Centre partition. Including formed padding, rubber skirt and front restraining strap for HB505R this large partition is fitted between two posts. £199.75
P1240 Bush. HB505R with large aluminium centre partition. Spring bolt guide. 4 off per partition. £1.20
C00810 Spring bolt handle. Used in the large aluminium centre partition. £1.20
P1241 Receiver. Floor fixing partition receiver for HB 505 models fitted with large aluminium centre partition (1992-1999). £2.35

COMPOSITE PADDING POLYPROPYLENE/FOAM

Polypropylene side padding material with built in foam cushioning in pearlescent silver, as fitted to the interior side panels of our horseboxes.

C79243/1	Composite Padding. PP SHEET/FOAM 1 x 735 x 2070mm HB401/505 right hand side.	£17.65
C79244/1	Composite Padding. PP SHEET/FOAM 1 x 735 x 2515mm HB401/505 left hand side.	£19.40
C79246/1	Composite Padding. PP SHEET/FOAM 1 x 735 x 2292mm HB501 right hand side.	£21.75
C79247/1	Composite Padding. PP SHEET/FOAM 1 x 735 x 2890mm HB501 left hand side.	£23.50

RETAINER BARS

C49450	Padding retainer 2070mm Twin lipped extrusion used between padding and kickboard on HB401 & 505.	£9.40
C49460	Padding retainer 2292mm Twin lipped extrusion used between padding and kickboard on HB510.	£10.60
C49455	Padding retainer 2515mm Twin lipped extrusion used between padding and kickboard on HB401 & 505.	£11.45
C49465	Padding retainer 2890mm Twin lipped extrusion used between padding and kickboard on HB510.	£13.20

PADDING FOR 1993-1998 MODELS

C79036	Padding 690 x 725mm 5.3mm thick grey padding material.	£12.95
C79032	Padding 2092 x 725mm 5.3mm thick grey padding material.	£29.95
C79031	Padding 2310 x 725mm 5.3mm thick grey padding material.	£37.15

PADDING FOR PRE 1992 HORSEBOXES

C79008	Padding 2310 x 725mm 1.5mm thick cream padding material.	£25.40
--------	--	--------

If you are unsure which padding material you require, give us a call prior to ordering!



HB505 double horsebox

To Order – See pages 4 & 5 for distributor contact details or call direct on 0845 4082 505



Increase the versatility of your 7' headroom livestock trailer by adding this optional horse partition kit. Versions are available to fit trailers with or without sheep decks.

Please note:
Colour and style of the partition leaf and breaching bars may differ from this illustration

TA510 12' long 7' headroom with KX0186 horse partition kit fitted











KX0180	Horse partition kit. TA5 (7' headroom with decks) horsebox style centre partition kit, includes breast/breaching bars and receivers.	£258.50
P1110/50SS	Linch pin. 1/4" stainless steel shaft 50mm long.	£1.20
KX0181	Horse partition kit. TA5 (7' headroom without decks) horsebox style centre partition kit, includes breast/breaching bars and receivers.	£258.50
KX0185	Horse partition kit. TA510 (7' headroom with decks) horsebox style centre partition kit, includes breast/breaching bars and receivers.	£258.50
KX0186	Horse partition kit. TA510 (7' headroom without decks) horsebox style centre partition kit, includes breast/breaching bars and receivers.	£258.50
KX0182	Horse partition fittings. Fittings for the kit only (if partition is to be used in two trailers).	£39.95
KX0190	Breaching bar. Aluminium tube breaching bar for TA5 7' headroom (trailer with decks).	£47.00
KX0191	Breaching bar. Aluminium tube breaching bar for TA5 7' headroom (trailer without decks).	£47.00
KX0195	Breaching bar. Aluminium tube breaching bar for TA510 7' headroom (trailer with decks).	£47.00
KX0196	Breaching bar. Aluminium tube breaching bar for TA510 7' headroom (trailer without decks).	£47.00
KX0170	Full width breast/breaching bar. TA5 7' models with decks fitted. (Horse partition fittings need to be installed).	£52.88
KX0171	Full width breast/breaching bar. TA5 7' models without decks. (Horse partition fittings need to be installed).	£52.88
KX0172	Full width breast/breaching bar. TA510 7' models with decks. (Horse partition fittings need to be installed).	£52.88
KX0173	Full width breast/breaching bar. TA510 7' models without decks. (Horse partition fittings need to be installed).	£52.88
AS7459	Fixing bracket. HB505 - Fixes the centre partition pole to the trailer roof.	£13.65
C00077	Clevis pin. Used to secure the centre partition pole to the upper bracket (HB505/510 or TA5 models with horse kit).	£1.75
F1913Z	R clip. Holds the centre partition clevis securely in place.	£0.30
C31250	Receiver bracket. Three hole breaching bar receiver bracket.	£6.45
C11153	Fixing plate. Used where the partition pole enters the trailer floor.	£4.70



HB610 with KX4320 window guard kit fitted

To Order – See pages 4 & 5 for distributor contact details or call direct on 0845 4082 505

HORSE PARTITION KITS







	KX0117 Full width partition kit. HB510XL Simply hang on the mounting rail & clip in place. £182.15
	1 KX0118 Full width partition kit. HB610 Simply hang on the mounting rail & clip in place. £188.00
	P10851 Head Partition kit. HB510XL & HB610 Bolts on to any existing full width partition. £47.00
	KX0107 Saloon door partition kit. One pair of short saloon type partition doors to fit all versions of HB510XL complete with rubber skirts and securing belt. £199.75
	KX0109 Saloon door partition kit. One pair of short saloon type partition doors to fit HB610 models complete with rubber skirts and securing belt. £211.50
	KX01092 Solid saloon door partition kit. One pair of tall saloon type partition doors (no rubber skirt) to fit all versions of HB510XL complete with securing belt. £223.25
	KX4335 Centre partition kit. Traditional style "side by side" partition system for carrying two large horses facing forwards in the HB510XL-10. £293.75
	KX0130 Centre partition kit. Traditional style "side by side" partition system for carrying two large horses facing forwards in the HB510XL. £293.75
	KX0129 Centre partition kit. Traditional style "side by side" partition system for carrying two large horses facing forwards in the HB610. £293.75



OPTIONAL ACCESSORIES

	KX0766 Roof vent kit. Pop-up roof vents (2) with fasteners for HB510XL-10. £47.00
	KX0765 Roof vent kit. Pop-up roof vents (4) with fasteners for HB510XL or HB610. £94.00
	KX4322 Window guard kit. Black powder coated bars (4) & fasteners for HB510XL-10. £47.00
	KX4321 Window guard kit. Black powder coated bars (6) & fasteners for HB510XL. £70.50
	KX4320 Window guard kit. Black powder coated bars (5) & fasteners for HB610. £58.75
	KX0240 Wheel chocks. Pair of wheel chocks & holders (fit on outside of trailer). £23.50
	2 KX01168 Breeching bar. HB510XL fits across rear ramp aperture (Black). £41.13
	KS26858 Breast bar. HB610 fits across front ramp aperture (Black). £25.60
	KS27258 Breeching bar. HB610 fits across rear ramp aperture (Black). £47.00

DEDICATED SPARE PARTS

	AS0767 Aluminium floor. Multi-planked Aluminium floor assembly to fit HB510XL-10. £395.00
	AS0770 Aluminium floor. Multi-planked Aluminium floor assembly to fit HB510XL. £420.00
	AS0725 Aluminium floor. Multi-planked Aluminium floor assembly to fit HB610. £505.00
	C80848 Rubber matting. One piece rubber matting to fit HB510XL (cut to fit HB510XL-10). £350.15
	C80849L Rubber matting. Left side Half matting to fit HB610. £211.50
	C80849R Rubber matting. Right side Half matting to fit HB610. £211.50
	KS3007 Rear doors. Pair of doors fitted above rear ramp on HB510XL 7' Headroom. £152.75
	KS3004 Rear doors. Pair of doors fitted above rear ramp on HB510XL 2.3M Headroom. £117.50
	KS3008 Rear doors. Pair of doors fitted above rear ramp on HB610 7' Headroom. £193.88
	KS3009 Rear doors. Pair of doors fitted above rear ramp on HB610 2.3M Headroom. £199.75
	C72053 GRP nosecone. Basic (non-storage) version for HB510XL models. £158.63
	C72049 GRP nosecone. Storage nose version for HB510XL models. £250.00
	C72056 GRP nosecone. Storage nose version for HB610 models. £376.00
	KS0920 Storage nose conversion kit. Full kit of parts to convert basic HB510XL models to the storage nose system. Includes GRP nosecone, upper front panel, sliding doors, track and all fasteners required. £340.75
	P1079 Spring lock. Large over-centre ramp fastener used on HB610 front & rear ramps. £9.50
	AS7792 Spring lock receiver. Large tab type used on rear ramp of HB610. £5.90
	AS7793 Spring lock receiver. Short tab type used on front ramp of HB610. £5.60
	3 P11135 Tie ring. With plastic skirt as fitted to interior HB510XL & HB610. £5.10

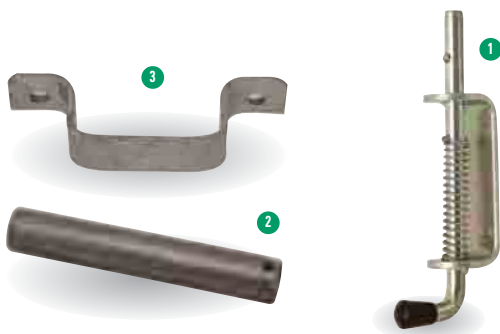

1	AS5870	Spring bolt. Used on cross divisions and GD rear ramps.	£7.65
	AS4862	Spring bolt. Used on the rear drop leaf of old livestock models (without taper rear pillar).	£10.40
	AS4818	Spring bolt. Rope operated on rear drop leaf of livestock trailer TA5, 510 & DP120G models (2 required).	£9.65
	AS0611	Tie ring. Galvanized steel tie ring on plate	£1.76
	P1083	Ramp fastener. LH fastener for combined ramp/door livestock trailers.	£12.35
	P1082	Ramp fastener. RH fastener for combined ramp/door livestock trailers.	£12.35
	AS4758	Hinge bracket. LH Lower Ramp side gate hinge bracket for P6/8G or older TA5/510 & DP models.	£5.30
	AS4756	Hinge bracket. LH Upper Ramp side gate hinge bracket for P6/8G or older TA5/510 & DP models.	£5.30
	AS4757	Hinge bracket. RH Lower Ramp side gate hinge bracket for P6/8G or older TA5/510 & DP models.	£5.30
	AS4755	Hinge bracket. RH Upper Ramp side gate hinge bracket for P6/8G or older TA5/510 & DP models.	£5.30
	KS0810	Hinge tube. Used on P6/P8 TA5G and TA510G models.*	£17.05
2	C20937	Hinge tube. Nylon coated hinge pin used on most livestock models.	£6.10
	KS0811	Hinge tube. Ramp hinge tubes (full set) for DP120.*	£17.05
	AS4965	Hinge socket. The hinge for the rear drop leaf of livestock trailer TA5, 510 & DP120G models (2 required).	£3.45

* Pre - Easyload models

	KS2978	Back rail. Fits above the rear ramp on DP120 (low ramp).	£23.50
	AS3040	Back rail. Fits above the rear ramp on P6e livestock models.	£18.80
	AS5756	Back rail. Fits above the rear ramp on TA5 (also TA5R and TA5G models).	£19.75
	KS2975	Back rail. Fits above the rear ramp on TA510 (7' headroom low ramp).	£41.15
	AS4855	Back rail. Fits above the rear ramp on TA510 (also TA510R and TA510G models).	£35.00
	AS4856	Back rail. TA510 - 7' headroom multi slatted backrail assembly.	£71.70
	AS4857	Back rail. TA5G - Guard rail over rear ramp.	£55.25
	C14342	Antiluce plate. Used on many livestock backrail assemblies.	£1.95
	P1162	Ramp spring. Used on DP120R (Pre 1983 painted trailer) and HB505R from April 1988 to April 1990 and HB containers from March 1990.	£17.05
	P1161	Ramp spring. Used on TA5, 510, & DP120 rear ramps.	£17.05
	AS0717	Ramp spring pivot. For ramp fitting on LTA5 and painted livestock models.	£4.10
3	C05871	Lifting handle. Fitted to the DP120 container body to facilitate removal.	£5.10
	C04737	Cross brace bracket. Fixes the livestock front panel cross brace to the first vertical pillar.	£1.20
	AS0744	Tie ring. Used in larger livestock trailers as well as the HB505RL, HB510XL and HB610.	£6.10

EASYLOAD™ RAMP SPARES



DP120 12' with Easyload™ ramp and optional ramp gate extensions

	C14214	Support stay. RH - For the EasyLoad™ livestock ramp mechanism.	£17.50
	C14215	Support stay. LH - For the EasyLoad™ livestock ramp mechanism.	£17.50
	C14212	Latch retainer. The RH safety catch that holds the EasyLoad™ release in place.	£2.30
	C14213	Latch retainer. The LH safety catch that holds the EasyLoad™ release in place.	£2.30
	C04211	Ramp release. Releases the inner EasyLoad™ ramp from its outer frame (2 per ramp).	£2.05

Model Specific

Livestock Cross Divisions

	KX4785	Cross division. 2000-2004 model catch - upper.	£82.25
	KX4785/7	Cross division. TA5 2000-2004 model - upper (7' headroom).	£82.25
	KX4786	Cross division. TA5 2000-2004 model - lower.	£82.25
	KX48775	Cross division. DP120G 1998/99 model - lower.	£88.15
	KX4787	Cross division. TA510 2000-2004 model - upper.	£88.15
1	KX4787/7	Cross division. TA510 2000-2004 model - upper (7' headroom).	£88.15
2	KX4788	Cross division. TA510 2000-2004 model - lower.	£88.15
	KX4789	Cross division. DP120 2000-2004 model - upper.	£88.15
	KX4790	Cross division. DP120 2000-2004 model - lower.	£88.15
	KX4775	Cross division. TA5G Late 2004 models with latching rails and heavy duty catch - Lower.	£76.38
	KX4777	Cross division. TA510G Late 2004 models with latching rails and heavy duty catch - Lower.	£88.13
	KX4779	Cross division. DP120 Late 2004 models with latching rails and heavy duty catch - Lower.	£82.25
	KX4875	Cross division. TA5G 1998/99 model - upper.	£82.25
	KX48755	Cross division. TA5G 1998/99 model - lower.	£82.25
	KX4876	Cross division. TA510G 1998/99 model - upper.	£88.15
	KX48765	Cross division. TA510G 1998/99 model - lower.	£88.15
	KX4877	Cross division. DP120G 1998/99 model - upper.	£88.15
	KX4822	Partition gate. TA5G - Partition incorporating gate for pre 1998 models with decks.	£99.90
	KX4823	Partition gate. TA510G - Partition incorporating gate for pre 1998 models with decks.	£99.90
3	KX4824	Partition gate. DP120G - Partition incorporating gate for pre 1998 models with decks.	£99.90

Small cross divisions are for trailers with sheep decks deployed.



Sealed Floor?
See page 74 for cross divisions to fit our sealed floor trailers.

When transporting livestock, full use should be made of partitions to ensure that the animals are not thrown about by the motion of the vehicle. This is one of the provisions of the Transit of Animals Regulations, and it is most important for the safe towing of the trailer.



To Order – See pages 4 & 5 for distributor contact details or call direct on 0845 4082 505



TA510 12' with optional ramp gate extensions

To Order – See pages 4 & 5 for distributor contact details or call direct on 0845 4082 505

LARGE CROSS DIVISIONS

KX4780	Cross division. TA5 2000-2004 model.	£176.25
KX4780/7	Cross division. TA5 2000-2004 model (7' headroom).	£188.00
KX4781	Cross division. TA510 2000-2004 model.	£188.00
KX4781/7	Cross division. TA510 2000-2004 model (7' headroom).	£199.75
KX4782	Cross division. DP120 2000-2004 model.	£199.75
KX4770	Cross division. TA5G Late 2004 models with latching rails and heavy duty catches.	£188.00
KX4771	Cross division. TA510G Late 2004 models with latching rails and heavy duty catches.	£188.00
KX4771/7	Cross division. TA510G Late 2004 models with latching rails and heavy duty catches.	£188.00
KX4772	Cross division. DP120 Late 2004 models with & latching rails heavy duty catches.	£199.75
KX4880	Cross division. TA5G 1998/99 model full height cross division.	£176.25
KX4881	Cross division. TA510G 1998/99 model full height cross division.	£188.00
KX4881/7	Cross division. TA510G 1998/99 model full height cross division (7' headroom).	£199.75
KX4882	Cross division. DP120G 1998/99 model full height cross division.	£199.75
KX4852/6	Cross division. TA5G pre-1998 full height cross division.	£176.25
KX4852/7	Cross division. TA5G pre-1998 full height cross division (7' headroom).	£188.00
KX4853/6	Cross division. TA510G pre-1998 full height cross division.	£188.00
KX4853/7	Cross division. TA510G pre-1998 full height cross division kit (7' headroom).	£199.75
KX4854/6	Cross division. DP120G pre-1998 full height cross division.	£199.75

Large cross divisions are used in trailers without decks when cattle is being carried.



DP120 10' with KX4782 large cross division fitted

When transporting livestock, full use should be made of partitions to ensure that the animals are not thrown about by the motion of the vehicle. This is one of the provisions of the Transit of Animals Regulations, and it is most important for the safe towing of the trailer.



Sealed Floor?
See page 74 for cross divisions to fit our sealed floor trailers.

1	AS4861	Spring bolt. With ring tail, used on timber livestock cross divisions.	£10.20
2	C00600	Swivel handle. Part of the spring bolt on galvanized cross divisions.	£0.60
3	C05273	Spring bolt receiver. Spring bolt receiver for the internal cross divisions, fixed to inside of roof.	£3.55
4	C05274	Spring bolt receiver. Double spring bolt receiver (fixes to roof).	£5.30
5	C11970	Guide. Guide plate for the catch used on the large and small cross divisions.	£4.95
6	AS4779	Catch. Used on the current design of large and small cross divisions.	£1.70
7	C11973	Locating bracket. Latch side, lower - used on the outside of the trailer to hold a stowed cross division.	£3.75
8	C11974	Locating bracket. Used on the outside of the trailer to hold a stowed cross division (centre - latch side of cross division).	£4.00
	C11975	Anti lift bracket. Used alongside the catch on the current design of large and small cross divisions.	£3.35
9	C14208	Locating bracket. Hinge side, centre - used on the outside of the trailer to hold a stowed cross division.	£2.25
10	C14209	Locating bracket. Secures the ramp gate extensions on the side of the trailer.	£1.30
	C14227	Locating bracket. Hinge side, upper - used on the outside of the trailer to hold a stowed cross division.	£2.80
11	C15227	Receiver channel. For spring bolts of large cross divisions TA5, 510 & DP120 models.	£3.55
	C498033	Cross division upright. 1720mm length used as vertical members in large livestock cross divisions.	£17.20
12	C74419	Pivot bush. Bolted to the livestock deck, this nylon bush acts as a pivot for the upper cross divisions.	£0.65
13	P1171	Spring. For all springbolts & galvanized cross division bolt pins.	£1.20
14	P1179	Spring. Compression spring used in cross division spring bolts.	£1.20
15	C75363	Capping insert. Fits into the end of the ramp gate vertical member to form a hinge.	£1.90
16	P1287	Spring. Return spring for the catch used on the current design of large and small cross divisions.	£1.20



For trailers without the sealed-floor system (up to Jan 2005 for TA5/510 models and up to May 2006 for DP120 models).



To Order – See pages 4 & 5 for distributor contact details or call direct on 0845 4082 505

SINGLE HEIGHT LIVESTOCK MODELS

KX4846	Cross division (Timber). P6e - To partition the trailer when carrying certain livestock (fits livestock variant only).	£64.65
KX4874	Cross division. P6/8G.	£70.50
KX4874/5	Cross division. P6/8 (5' headroom) - Standard cross division.	£70.50
KX4870	Cross division. TA5 (4' headroom) Standard cross division.	£82.25
KX4760	Cross division. To suit later type TA5G 4' headroom (models with tapered rear pillars).	£82.25

When transporting livestock, full use should be made of partitions to ensure that the animals are not thrown about by the motion of the vehicle. This is one of the provisions of the Transit of Animals Regulations, and it is most important for the safe towing of the trailer.



TA5 10' (4' headroom)



To Order – See pages 4 & 5 for distributor contact details or call direct on 0845 4082 505



P6G livestock trailer fitted with KX4874 cross division

Model Specific

Livestock Decks



KX0001P	Sheep deck kit. Plywood decks for older TA5G 8' model.	£287.90
KX0002P	Sheep deck kit. Plywood decks for older TA5G 10' model.	£311.40
KX0011P	Sheep deck kit. Plywood decks for older TA510G 10' model.	£340.75
KX0012P	Sheep deck kit. Plywood decks for older TA510G 12' model.	£376.00
KX0022P	Sheep deck kit. Plywood decks for older DP120G 12' model.	£387.75
KX0023P	Sheep deck kit. Plywood decks for older DP120G 14' model.	£411.25
1 AS5311	Deck support. TA5G deck support tension beam, top hat type that is fixed from the outside of the trailer.	£23.40
AS5312	Deck support. TA510G deck support tension beam, top hat type that is fixed from the outside of the trailer.	£25.35
AS5313	Deck support. DP120G deck support tension beam, top hat type that is fixed from the outside of the trailer.	£27.10
2 AS5310	Clamp bolt. Used with old type decks this bolt secures the deck tension beam (2 per trailer).	£2.80
3 C19460	Deck support. TA5G - top hat section for deck support.	£12.85
C19455	Deck support. TA510G - top hat section for deck support.	£14.80
C19450	Deck support. DP120G - top hat section for deck support.	£16.55
KS0500	Dropleaf. Aluminium rampdeck kit for TA5G.	£188.00
KS0501	Dropleaf. Aluminium rampdeck kit for TA510G.	£211.50
KS0502	Dropleaf. Aluminium rampdeck kit for DP120G.	£223.25
C45095	Hinge bracket. For folding sheep decks on TA5, 510 & DP120 models.	£2.05
4 C05083	Hinge pin. Cranked hinge pin for old type fold-up decks on TA5G, TA510G and DP120G.	£1.75
5 P1075	Hinge. Double knuckle hinge for folding deck systems.	£7.65
C14540	Receiver bracket. Part of the rear deck lifting bracket on old livestock models.	£1.55
C11972	Double receiver. Used on the side of livestock trailers where the front and rear decks join, allowing the gate to operate in either position.	£4.95

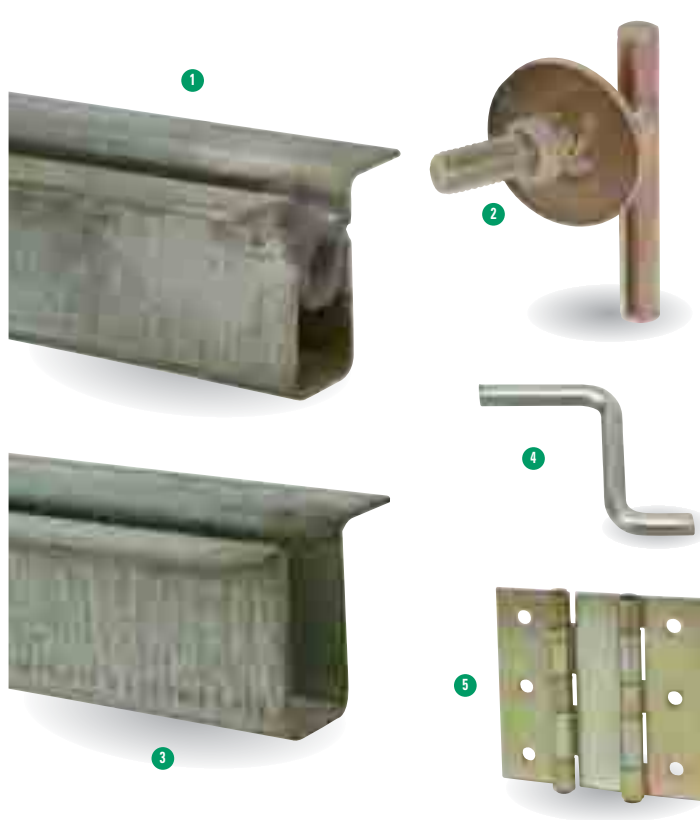

KX4950 Container removal kit. Includes four adjustable legs, fittings adjustment tool and guide to removing and re-fitting your DP120 container (Not suitable for Tri-axle trailers). £111.63

Ifor Williams Trailers also manufactures a wide range of canopies as seen on this Defender. Our sales department will be happy to advise on canopies to fit your pickup.



Land Rover defender fitted with V383 Canopy towing DP120 12'

To Order – See pages 4 & 5 for distributor contact details or call direct on 0845 4082 505

DECK SECTIONS

C44166	Deck section. Deck inner section (4' long RH) TA5.	£52.90
C44167	Deck section. Deck inner section (4' long LH) TA5.	£52.90
C44155	Deck section. Deck inner section (4' long RH) TA510.	£64.65
C44161	Deck section. Deck inner section (4' long LH)TA510.	£64.65
C44174	Deck section. Deck inner section (4' long RH) DP.	£64.65
C44175	Deck section. Deck inner section (4' long LH) DP.	£64.65
C44154	Deck section. Deck outer section (4' long RH) TA5/510/DP.	£70.50
C44160	Deck section. Deck outer section (4' long LH) TA5/510/DP.	£70.50
C44164	Deck section. Deck inner section (6' long RH) TA5.	£58.75
C44165	Deck section. Deck inner section (6' long LH) TA5.	£58.75
C44153	Deck section. Deck inner section (6' long RH) TA510.	£70.50
C44159	Deck section. Deck inner section (6' long LH) TA510.	£70.50
C44172	Deck section. Deck inner section (6' long RH) DP.	£70.50
C44173	Deck section. Deck inner section (6' long LH) DP.	£70.50
C44152	Deck section. Deck outer section (6' long RH) TA5/510/DP.	£105.75
C44158	Deck section. Deck outer section (6' long LH) TA5/510/DP.	£105.75
C44162	Deck section. Deck inner section (8' long RH) TA5.	£70.50
C44163	Deck section. Deck inner section (8' long LH) TA5.	£70.50
C44151	Deck section. Deck inner section (8' long RH) TA510.	£76.40
C44157	Deck section. Deck inner section (8' long LH) TA510.	£76.40
C44170	Deck section. Deck inner section (8' long RH) DP.	£76.40
C44171	Deck section. Deck inner section (8' long LH) DP.	£76.40
C44150	Deck section. Deck outer section (8' long RH) TA5/510/DP.	£135.15
C44156	Deck section. Deck outer section (8' long LH) TA5/510/DP.	£135.15



DECK COMPONENTS

1	AS4192	Deck retainer. Incorporating threaded stud for deck retainer latch and spacer (latch and spacer not fitted).	£2.35
2	AS4194	Deck retainer. Similar to AS4194 with the addition of ramp gate receiver (fitted to LH side of trailer).	£2.35
	C14193	Deck retaining slider. Holds the folding deck in the raised position.	£1.05
	C74194	Retainer spacer. Part of the deck retainer catch, fits between the slider and the base.	£1.05
	P12810	Plastic spacer washer.	£0.10
	C24211	Deck brace. TA5 - for the latest type of folding decks.	£28.90
	C24212	Deck brace. TA510 - for the latest type of folding decks.	£28.90
	C24213	Deck brace. DP120 - for the latest type of folding decks.	£28.90
3	P1269	Buffer. Fitted to the deck cross beam to prevent deck rattle.	£0.30
	AS1860	Rear barrier. TA5 - rear ramp/barrier for use with EasyLoad™ ramp system.	£146.90
	AS1861	Rear barrier. TA51 barrier for use with EasyLoad™ ramp system.	£146.90
	AS1862	Rear barrier. DP120 - rear ramp/barrier for use with EasyLoad™ ramp system.	£146.90
	C44100	Front deck leaf. TA5 - fold down treadplate section at front of trailer.	£76.40
	C44101	Front deck leaf. TA510 - fold down treadplate section at front of trailer.	£88.15
	C44102	Front deck leaf. DP120 - fold down treadplate section at front of trailer.	£94.00
	C44932	Deck hinge. This part of the hinge is fitted to the treadplate deck section.	£1.75
4	C14542	Receiver bracket. Fits on the deck side rail, to locate the deck crossbeams.	£1.55



1 & 2 Shown fitted with C14193 & C74194



	KS0046	Ramp gates (pair). P6/8 Aluminium rampgates.	£94.00
	KS2991	Ramp gates (pair). TA5 (cattle) current production version.	£164.50
	KS29911	Ramp gate RH. TA5 (cattle) current production version.	£82.25
	KS29912	Ramp gate LH. TA5 (cattle) current production version.	£82.25
	KS2993	Ramp gates (pair). TA510 (cattle) current production version.	£188.00
	KS29931	Ramp gate RH. TA510 (cattle) current production version.	£94.00
	KS29932	Ramp gate LH. TA510 (cattle) current production version.	£94.00
	KS2995	Ramp gates (pair). DP120 (cattle) current production version.	£188.00
	KS29951	Ramp gate RH. DP120 (cattle) current production version.	£94.00
	KS29952	Ramp gate LH. DP120 (cattle) current production version.	£94.00
	KS0044	Ramp gates (pair). TA5 Aluminium rampgate kit.	£164.50
	KS0045	Ramp gates (pair). TA510G/DP120G (older models) Aluminium rampgate pair.	£188.00
	KS0048	Ramp gates (pair). Horsebox container rampgate kit (rear ramp).	£188.00
1	KX4890	Ramp gate extension. TA5/510 rampgate extension (2'wide) allows the ramp gate to be extended for better stock control.	£111.63
2	KX4891	Ramp gate extension. DP120 rampgate extension (4'wide) allows the ramp gate to be extended for better stock control.	£152.75
	C14737	Rampgate bracket. P6e RH upper rampgate support bracket fits inside canopy.	£4.05
3	C14738	Rampgate bracket. P6e LH upper rampgate support bracket fits inside canopy.	£4.05
	C74737	Rampgate Spigot. P6e Fitted between the ramp gate and support bracket.	£4.25
	C04207	Rampgate pin. Used to secure the lower (pivot) leg of the rampgate in the trailer floor.	£3.30
	C14732	Rampgate catch. Allows one rampgate to hold the other closed.	£2.50
4	C497954	Rampgate plank. 1605mm length of rampgate plank.	£13.80
5	C499446	Rampgate channel. 1480mm vertical rampgate channel.	£14.90
6	C14209	Locating bracket. Rampgate extension bracket, also used on some earlier cross division front panel mountings.	£1.30
7	C24220	Retaining pin. For Rampgate extensions on TA5, 510 & DP120 models.	£1.00
8	C75363	Capping insert. fits into end of ramp gate vertical member to hold hinge or retainer pieces.	£1.90



To Order – See pages 4 & 5 for distributor contact details or call direct on 0845 4082 505



TA5 12' with ramp gate extensions in use

To Order – See pages 4 & 5 for distributor contact details or call direct on 0845 4082 505



DP120 14' Tri-axle with decks and KX4920 Sump tank fitted

SUMP TANK KITS ETC.

	1 KX4900 Sump tank kit TA5. Includes tank with screw-off lids, a pair of floor drain points, rear dam & all fasteners required to install (This kit is dealer fit only).	£188.00
	KX4910 Sump tank kit TA510. Includes tank with screw-off lids, a pair of floor drain points, rear dam & all fasteners required to install (This kit is dealer fit only).	£188.00
	KX4920 Sump tank kit DP120S. Includes tank with screw-off lids, a pair of floor drain points, rear dam & all fasteners required to install (This kit is dealer fit only).	£188.00
	KX0245 Skid carrier & propstands. For DP120 "Sealed floor" carrier, legs and brackets (Loading skids not included - Trailers from Serial Number 451329 onwards).	£123.38

CROSS DIVISIONS FOR SEALED FLOOR MODELS

	KX4765 Large cross division TA5. 6' headroom - sealed floor models only.	£176.25
	KX4765/7 Large cross division TA5. 7' headroom - sealed floor models only.	£188.00
	KX4750 Small cross division (upper) TA5. 6' headroom - sealed floor models only.	£76.38
	KX4750/7 Small cross division (upper) TA5. 7' headroom - sealed floor models only.	£76.38
	KX4751 Small cross division (lower) TA5. Sealed floor models only.	£76.38
	KX4766 Large cross division TA510. 6' headroom - sealed floor models only.	£188.00
	KX4766/7 Large cross division TA510. 7' headroom - sealed floor models only.	£199.75
	KX4752 Small cross division (upper) TA510. 6' headroom - sealed floor models only.	£82.25
	KX4752/7 Small cross division (upper) TA510. 7' headroom - sealed floor models only.	£82.25
	KX4753 Small cross division (lower) TA510. Sealed floor models only.	£82.25
	KX4767 Large cross division DP120S. Sealed floor models only.	£199.75
	KX4754 Small cross division (upper) DP120S. Sealed floor models only.	£82.25
	KX4755 Small cross division (lower) DP120S. Sealed floor models only.	£82.25
	KX4889 Cross division mounting kit. Fully revised front panel mounting system secures cross divisions using a central linch pin system allowing easier fitting and removal.	£17.65

MISCELLANEOUS SPARE PARTS

2	KS4925 Sump drain cap. Black screw-off cap complete with seal & fixing chain.	£5.90
	KS4926 Sump drain seal. Pack of 2 cap seals.	£3.25
3	KS4927 Sump drain cover. Lift out cover for internal drain point with spring & nut.	£8.50
	C12065 Rear dam. Formed steel rear dam for TA5 models.	£9.40
	C12064 Rear dam. Formed steel rear dam for TA510 models.	£9.40
	C48920 Rear dam. Aluminium rear dam extrusion for DP120 models (trim to fit).	£8.80
	C89300 Container seal set. Replacement seal set for DP120S (Models up to 14' long).	£3.55





LM146 with KX1060 dropside kit fitted

To Order – See pages 4 & 5 for distributor contact details or call direct on 0845 4082 505

DROPSIDE KITS *

KX1000	Dropside Kit. LT/LM85 including headboard.	£235.00
KX1001	Dropside Kit. LT/LM85 Contains dropsides & tailboard (no headboard).	£193.88
KX1010	Dropside Kit. LT/LM105 including headboard.	£311.38
KX1011	Dropside Kit. LT/LM105 Contains dropsides & tailboard (no headboard).	£235.00
KX1020	Dropside Kit. LT/LM125 including headboard.	£340.75
KX1021	Dropside Kit. LT/LM125 Contains dropsides & tailboard (no headboard).	£270.25
KX1040	Dropside Kit. LT/LM106 including headboard.	£329.00
KX1050	Dropside Kit. LT/LM126 including headboard.	£352.50
KX1051	Dropside Kit. LT/LM126 Contains dropsides & tailboard (no headboard).	£276.13
KX1060	Dropside Kit. LT/LM146 including headboard.	£376.00
KX1061	Dropside Kit. LT/LM146 Contains dropsides & tailboard (no headboard).	£305.50
KX1060/76	Dropside Kit. LT/LM146 (7'6"wide old model) including headboard.	£399.50
KX1070	Dropside Kit. LT/LM166 including headboard.	£411.25
KX1072	Dropside Kit. LT/LM166 including headboard.	£340.75
KX1071	Dropside Kit. LT/LM166 Contains dropsides & tailboard (no headboard).	£381.88
KX1070/76	Dropside Kit. LT/LM167 including headboard.	£458.25
KX1073	Dropside Kit. CT167 including headboard.	£364.25
KX1081	Dropside Kit. LM186 including headboard.	£470.00
KX1081/76	Dropside Kit. LM187G including headboard.	£528.75

* Dropside kits include centre pillars, rear pillars, tailboard and fixing kit. Available with or without headboard.

DROPSIDE COMPONENTS

AS2270	Dropside. LT/LM 85 - Right hand dropside panel.	£64.65
AS2271	Dropside. LT/LM 85 - Left hand dropside panel.	£64.65
AS2250	Dropside. LT/LM 10' - Right hand dropside panel (5' panel).	£41.15
AS2251	Dropside. LT/LM 10' - Left hand dropside panel (5' panel).	£41.15
AS2255	Dropside. LT/LM 12' - Right hand dropside panel (6' panel).	£52.90
AS2256	Dropside. LT/LM 12' - Left hand dropside panel (6' panel).	£52.90
AS2260	Dropside. LT/LM 14' - Right hand dropside panel (7' panel).	£58.75
AS2261	Dropside. LT/LM 14' - Left hand dropside panel (7' panel).	£58.75
AS2265	Dropside. LT/LM 16' - Right hand dropside panel (8' panel).	£64.65
AS2266	Dropside. LT/LM 16' - Left hand dropside panel (8' panel).	£64.65
AS5207	Support Hinge. LT/LM Part of RH dropside panel - this is the right hand hinge on this panel.	£8.80
AS5208	Support Hinge. LT/LM Part of RH dropside panel - this is the left hand hinge on this panel.	£8.80
AS5209	Support Hinge. LT/LM Part of RH dropside panel - this is the centre pillar on this panel.	£8.80
AS5373	Support Hinge. LT/LM Part of LH dropside panel - this is the right hand hinge on this panel.	£8.80
AS5374	Support Hinge. LT/LM Part of LH dropside panel - this is the left hand pillar on this panel.	£8.80
AS5210	Support Hinge. LT/LM Part of LH dropside panel - this is the centre hinge on this panel.	£8.80
AS2230	Centre Pillar. LT/LM Centre pillar assembly for trailers with dropsides (not LT/LM85).	£24.05
AS5262	Centre Pillar. LT/LM Centre pillar as above but without linch pins, chains etc....	£20.85
AS5263	Rear Pillar. LT/LM (all models) RH welded assembly.	£18.85
AS5264	Rear Pillar. LT/LM (all models) LH welded assembly.	£18.85
AS5041	Rear Corner Pillar. TT85G RH (Post May 2000).	£22.90
AS5042	Rear Corner Pillar. TT85G LH (Post May 2000).	£22.90
C00178	Locking Handle. Secures the tipper tailgate shut.	£5.64



To Order – See pages 4 & 5 for distributor contact details or call direct on 0845 4082 505



LM146 with KX8568 meshside kit (trailer already has a ramp, winch and dropsides kit fitted)

MESH SIDE KITS

KX8553	Mesh side kit. LT/LM 85 trailers fitted with a tailboard.	£376.00
KX8554	Mesh side kit. LT/LM105 trailers fitted with a tailboard.	£481.75
KX8572	Mesh side kit. LT/LM105 trailers fitted with a ramp.	£434.75
KX8559	Mesh side kit. LT/LM106 trailers fitted with a tailboard.	£493.50
KX8573	Mesh side kit. LT/LM106 trailers fitted with a ramp.	£446.50
KX8590	Mesh side kit. LT/LM125 trailers fitted with a tailboard.	£522.88
KX8592	Mesh side kit. LT/LM125 trailers fitted with a ramp.	£428.88
KX8591	Mesh side kit. LT/LM126 trailers fitted with a tailboard.	£534.63
KX8593	Mesh side kit. LT/LM126 trailers fitted with a ramp.	£434.75
KX8562	Mesh side kit. LT/LM146 trailers fitted with a tailboard.	£552.25
KX8568	Mesh side kit. LT/LM146 trailers fitted with a ramp.	£440.63
KX8662	Mesh side kit. LT/LM147 trailers fitted with a tailboard.	£575.75
KX8668	Mesh side kit. LT/LM147 trailers fitted with a ramp.	£470.00
KX8563	Mesh side kit. LT/LM166 trailers fitted with a tailboard.	£575.75
KX8569	Mesh side kit. LT/LM166 trailers fitted with a ramp.	£470.00
KX8672	Mesh side kit. LT/LM167 trailers fitted with a tailboard.	£605.13
KX8678	Mesh side kit. LT/LM167 trailers fitted with a ramp.	£499.38
KX8577	Mesh side kit. LM186 trailers fitted with a tailboard.	£675.63
KX8578	Mesh side kit. LM186 trailers fitted with a ramp.	£628.63
KX8682	Mesh side kit. LT/LM187 trailers fitted with a tailboard.	£705.00
KX8688	Mesh side kit. LT/LM187 trailers fitted with a ramp.	£599.25

MESH SIDE COMPONENTS

AS8427	Mesh side panel. LT/LM85 8' individual mesh side panel.	£111.65
AS0191	Mesh side panel. LT/LM/TT 10' individual mesh side panel.	£64.65
AS0221	Mesh side panel. LT/LM 12' individual mesh side panel.	£80.80
AS8448	Mesh side panel. LT/LM 14' individual mesh side panel.	£90.50
AS8441	Mesh side panel. LT/LM 16' right hand individual mesh side panel.	£123.40
KX8596	Tie bar brace. For mesh sides on LM/LT1*6.	£17.63
KX8597	Tie bar brace. For mesh sides on LT/LM1*5.	£17.63
AS8412	Ladder rack. LT/LM 5 series - incorporating mesh panel, for use with mesh sides (Not LT/LM 85).	£88.15
AS8417	Ladder rack. LT/LM 6 series - incorporating mesh panel, for use with mesh sides.	£94.00
AS8429	Ladder rack. LT/LM85 - incorporating mesh panel, for use with mesh sides.	£82.25
AS8424	Mesh rear panel. LT/LM 5 series, used with mesh sides, the rear panel fits over the tailboard (Not LT/LM85).	£82.25
AS8426	Mesh rear panel. 6 series, used with mesh sides, the rear panel fits over the tailboard.	£88.15
AS8428	Mesh rear panel. LT/LM85, used with mesh sides, the rear panel fits over the tailboard.	£70.50
AS5258	Rear pillar. LT/LM right hand rear mesh side pillar.	£33.80
AS5259	Rear pillar. LT/LM left hand rear mesh side pillar.	£30.60
AS5266	Centre pillar. For LT/LM models fitted with meshsides, includes linch pin receivers.	£36.40



These mesh sides are for non-metric GD models (up to Feb 2006 for GD4 models or May 2005 for GD5 models), See page 81 for GD metric series

GD85 with KX8533 mesh side kit fitted

MESH SIDE KITS

Includes front panel, all fasteners and rear panel.

KX8530A	Mesh Side Kit. GD64 trailers fitted with a tailboard.	£323.13
KX8530	Mesh Side Kit. GD64 trailers fitted with a ramp.*	£258.50
KX8532A	Mesh Side Kit. GD84 trailers fitted with a tailboard.	£358.38
KX8532	Mesh Side Kit. GD84 trailers fitted with a ramp.*	£293.75
KX8533A	Mesh Side Kit. GD85 trailers fitted with a tailboard.	£376.00
KX8533	Mesh Side Kit. GD85 trailers fitted with a ramp.*	£311.38
KX8534A	Mesh Side Kit. GD105 trailers fitted with a tailboard.	£423.00
KX8534	Mesh Side Kit. GD105 trailers fitted with a ramp.*	£358.38
KX8538A	Mesh Side Kit. GD106 trailers fitted with a tailboard.	£434.75
KX8538	Mesh Side Kit. GD106 trailers fitted with a ramp.*	£370.13
KX8536	Mesh Side Kit. GD125 trailers fitted with a ramp.*	£405.38
KX8536A	Mesh side kit. GD125 trailers fitted with a tailboard.	£452.38
KX8540	Mesh Side Kit. GD126 trailers fitted with a ramp.*	£417.13
KX8636	Mesh Side Kit. P6e Mesh side kit including mesh ladder rack and all fittings. For trailers fitted with a tailboard.*	£211.50
KX8635	Mesh Side Kit. P6e Mesh side kit including mesh ladder rack, rear panel and all fittings. For trailers fitted with a tailboard.	£252.63
KX0602	Mesh Side Kit. GX84 Mesh side kit including mesh ladder rack and all fittings.	£293.75
KX0605	Mesh side kit. GX105 mesh side kit including mesh ladder rack and fittings.	£358.38
KX0603	Mesh Side Kit. GX106 Mesh side kit including mesh ladder rack and all fittings.	£370.13
KX0606	Mesh side kit. GX126 mesh side kit including mesh ladder rack and fittings.	£405.38

* No rear panel on ramp models.

MESH SIDE COMPONENTS

AS8531	Mesh Side Panel. GD64 Right Hand Individual mesh side panel.	£84.60
AS8530	Mesh Side Panel. GD64 Left Hand mesh side panel.	£84.60
AS8532	Mesh Side Panel. GD84/85 - Right hand mesh side panel.	£105.75
AS8533	Mesh Side Panel. GD84/85 - Left hand mesh side panel.	£105.75
AS8534	Mesh Side Panel. GD105 Right hand Individual mesh side panel.	£146.90
AS8535	Mesh Side Panel. GD105 Left Hand Individual mesh side panel.	£146.90
AS8540	Mesh Side Panel. GD126 Right Hand Individual mesh side panel.	£176.25
AS8541	Mesh Side Panel. GD126 Left Hand Individual mesh side panel.	£176.25
AS8635	Mesh Side Panel. P6e - Right hand mesh side panel (Models from 1997 onward).	£88.15
AS8636	Mesh Side Panel. P6e - Left hand mesh side panel (Models from 1997 onward).	£88.15
C20020	Tie bar brace. For mesh sides on GD*4.	£17.63
C20021	Tie bar brace. For mesh sides on GD85/1*5.	£17.63
AS8550	Ladder Rack. GD4 Series - Incorporating mesh panel, for use with mesh sides.	£70.50
AS8551	Ladder Rack. GD5 Series - Incorporating mesh panel, for use with mesh sides.	£76.40
AS8552	Ladder Rack. GD 6 Series - Incorporating mesh panel, for use with mesh sides.	£82.25
AS8219	Ladder Rack. P6e - Incorporating mesh panel, for use with mesh sides.	£52.88
AS8547	Mesh Rear Panel. GD 4 Series, Used with mesh sides, the rear panel fits over the tailboard.	£52.88
AS8546	Mesh Rear Panel. GD 5 Series, Used with mesh sides, the rear panel fits over the tailboard.	£58.75
AS8549	Mesh Rear Panel. GD Major, Used with mesh sides, the rear panel fits over the tailboard.	£64.63
AS8637	Mesh Rear Panel. P6e, Used with mesh sides, the rear panel fits over the tailboard.	£58.75

To Order – See pages 4 & 5 for distributor contact details or call direct on 0845 4082 505



TT105 with optional propstands and KX8581 mesh side kit fitted



MESH SIDE KITS



KX8570 Mesh Side Kit. TT85 Mesh side kit including mesh ladder rack, rear panel and all fittings. For trailers fitted with a tailboard. **£376.00**



KX8581 Mesh Side Kit. TT105 Split mesh side kit including mesh ladder rack, rear panel and all fittings. For trailers fitted with a tailboard. **£481.75**



KX8586 Mesh Side Kit. TT126 Split mesh side kit including mesh ladder rack, rear panel and all fittings. For trailers fitted with a tailboard. **£534.63**

MESH SIDE COMPONENTS



AS9782 Mesh Side Panel. TT85 Individual mesh side panel. **£111.65**



AS9780 Mesh Front Panel. For use with mesh sides, fits over the fixed ladder rack on the TT85 models. **£52.90**



AS0187 Mesh Rear Panel. TT105, Used with mesh sides, the rear panel fits over the tailboard. **£58.75**



AS0700 Mesh Rear Panel. TT126, Used with mesh sides, the rear panel fits over the tailboard. **£64.65**

AS5035 Rear Post. TT85 Right hand rear mesh side pillar. **£31.55**

AS5036 Rear Post. TT85 Left hand rear mesh side pillar. **£31.55**

AS5045 Rear Post. TT85 Right hand rear mesh side pillar (2000 on). **£30.55**

AS5046 Rear Post. TT85 Left hand rear mesh side pillar (2000 on). **£30.55**

AS0204 Rear Post. TT105 Right hand rear mesh side pillar (2000 on). **£28.20**

AS0205 Rear Post. TT105 Left hand rear mesh side pillar (2000 on). **£28.20**

AS5266 Centre Pillar. For TT models, includes linch pin receiver. **£36.40**

C00178 Locking handle. Secures the tipper tailgate shut. **£5.64**



LT85 with KX1000 dropside kit and AS8416 ladder rack fitted

To Order – See pages 4 & 5 for distributor contact details or call direct on 0845 4082 505

FOR THE LT/LM SERIES TRAILERS

1	KX1100 Headboard. LT/LM 85 complete headboard.	£70.50
	KX1110 Headboard. LT/LM 5 Series complete headboard (Not LT/LM 85).	£76.38
	KX1120 Headboard. LT/LM 6 Series complete headboard.	£82.25
	KX1120/76 Headboard. LT/LM 7 series complete headboard.	£99.88
	AS2160 Tailboard. LT/LM85 Complete tailboard assembly.	£52.90
2	AS2151 Tailboard. LT/LM5 Series Complete tailboard assembly (Not LT/LM85).	£58.75
	AS2155 Tailboard. LT/LM6 Series Complete tailboard assembly.	£64.65
	AS2156 Tailboard. LT/LM7 Series Complete tailboard assembly.	£70.50
	AS2175 Tailboard. TT85 Complete tailboard assembly.	£52.90
	AS2176 Tailboard. TT105 Complete tailboard assembly.	£58.75
	KS0332 Tailboard. TT126 complete tailboard assembly.	£64.63
	AS5276 Tailboard Member. LT/LM - RH Vertical tailboard member.	£11.75
	AS5277 Tailboard Member. LT/LM - LH Vertical tailboard member.	£11.75
3	AS8416 Ladder Rack. LT/LM 85 - Open framed design.	£52.88
	AS8409 Ladder Rack. LT/LM 5 Series - Open framed design (Not LT/LM 85).	£52.88
	AS8408 Ladder Rack. LT/LM 6 Series - Open framed design.	£58.75
	AS8449 Ladder Rack. LT/LM 7 Series - Open framed design.	£76.38
	KX5378 Harvest Ladder. Fits most LT/LM 6 series trailers (Rear sockets have triangles on).	£117.50
	AS5378 Harvest Ladder Sockets. Allows the fitting of our harvest ladder to LT/LM 6 series trailers.	£15.10

Please note: LT/LM ladder rack can only be fitted to a trailer with a headboard.

FOR THE GD/GX SERIES TRAILERS

KS0230 Tailboard. GD4 Series Complete tailboard assembly and fittings.	£52.88
KS0231 Tailboard. GD5 Series Complete tailboard kit.	£55.23
KS0232 Tailboard. GD6 Series Complete tailboard assembly and fittings.	£58.75
AS4992 Tailboard Hinge. RH hinge weld assembly For GD models.	£11.50
AS4993 Tailboard Hinge. LH hinge weld assembly For GD models.	£11.50
AS8504 Ladder Rack. GD 4 Series - Open framed design.	£47.00
AS8505 Ladder Rack. GD 5 Series - Open framed design.	£52.88
AS8506 Ladder Rack. GD 6 Series - Open framed design.	£58.75
AS0587 Ladder Rack. GX84 - open framed design.	£52.88
AS0589 Ladder Rack. GX105 - open framed design.	£52.88
AS0591 Ladder Rack. GX106 - open framed design.	£58.75



For ladder rack incorporating mesh panel please refer to the mesh sides section.









To Order – See pages 4 & 5 for distributor contact details or call direct on 0845 4082 505



LM146 with dropside & meshside kit, winch and KX1420 high ramp and optional propstands fitted

Adding a high ramp to the LT/LM Trailer range, will really save you time when loading and unloading wheeled equipment such as mowers.

FOR LT/LM & CT166 MODELS

	KX1440 High ramp. LT/LM 85 series includes hinges and all fittings to convert a trailer which has a tailboard. £352.50
	KX1430 High ramp. LT/LM 5 series includes hinges and all fittings to convert a trailer which has a tailboard (Not LT/LM85). £364.25
	KX1425 High ramp. LT/LM 6 beavertail Includes hinges and all fittings to convert a trailer which has a tailboard. £376.00
	KX1420 High ramp. LT/LM 6 series Includes hinges and all fittings to convert a trailer which has a tailboard. £376.00
	KX1420/76 High ramp. LT/LM 7 series Includes hinges and all fittings to convert a trailer which has a tailboard. £440.63
	KX1461 Tailboard / ramp. CT166 short tailboard/ramp with loading ramp edge, same height as dropsides. £99.90
	KX1460 High ramp. CT166 Approx. 1 metre high to convert the standard short tailboard/ramp. £211.50
	P1189 Gas spring. CT166/167 models fitted with 1 metre high ramp. £44.60

RAMPS & RAMP PARTS GD MODELS



KS8511 Rear ramp. GD4 series complete rear ramp. £199.75
KS0557 Rear ramp. GP84GTA plant trailer complete ramp. £270.25
KS8513 Rear ramp. GD 5 series complete ramp. £252.65
KS8518 Rear ramp. GP106GM complete ramp. £311.40
KS8557 Rear ramp. Rear ramp assembly for GX106. £323.15
C05869 Hinge rod. GP106 loading ramp hinge rod. £17.60
AS5581 Hinge. Ramp hinge welded assembly for GX106. £24.70
KX5105 Knife edge. GX105 bolt on component giving knife-edge to the ramp. £17.63
KX5115 Knife edge. GX106 bolt on component giving knife-edge to the ramp. £17.63
AS4996 Hinge bracket. GD106/126 ramp hinge bracket. £13.15
AS5586 Antiluce plate. Used on GP74 plant trailer rear ramps. £5.90
AS5280 Rear pillar. LT/LM rear pillar for high ramp (RH). £40.60
AS5281 Rear pillar. LT/LM rear pillar for high ramp (LH). £40.60
C14473 Angle cleat. Used to hold the ramp spring adjustor on many models (usually welded in place). £1.70
P1168 Ramp spring. Used on the GD range of trailers. £8.80
P1167 Ramp spring. Used on heavy duty GD range trailers. £21.75



GD85 ramp model with propstand kit KX0221 fitted

GD DEDICATED KITS

KX0221	Propstand kit. Standard 35mm propstands for GD4&5 series models.	£35.25
KX0231	Propstand kit. Heavy duty ribbed propstands for GD6 series models.	£70.50
KS3100	Ramp kit. Replacement ramp assembly GD4*.	£183.30
KX1499	Ramp kit. Replacement ramp assembly GD5*.	£205.65
KS3108	Tailboard kit. For converting GD4 series from ramp models.	£88.15
KS3109	Tailboard kit. For converting GD5 series from ramp models.	£70.50
KX0658	Aluminium floor kit. GD64.	£105.75
KX0659	Aluminium floor kit. GD84.	£141.00
KX0660	Aluminium floor kit. GD85.	£176.25
KX0661	Aluminium floor kit. GD105.	£223.25
KX0662	Aluminium floor kit. GD125.	£270.25

* Does not include gas strut or hinge tubes.



GD105 ramp model with mesh side kit KX8004 fitted

MESH SIDE KITS

KX8010	Ladder rack. GD4 series - open framed design.	£47.00
KX8011	Ladder rack. GD5 series - open framed design.	£52.88
AS3122	Ladder rack. GD4' with mesh panel.	£88.13
AS3123	Ladder rack. GD5' with mesh panel.	£94.00
KX8000A	Mesh side kit. GD64 tailboard.	£323.13
KX8000	Mesh side kit. GD64 ramp.	£258.50
KX8002A	Mesh side kit. GD84 tailboard.	£358.38
KX8002	Mesh side kit. GD84 ramp.	£293.75
KX8003A	Mesh side kit. GD85 tailboard.	£376.00
KX8003	Mesh side kit. GD85 ramp.	£311.38
KX8004A	Mesh side kit. GD105 tailboard.	£423.00
KX8004	Mesh side kit. GD105 ramp.	£358.38
KX8006A	Mesh side kit. GD125 tailboard.	£470.00
KX8006	Mesh side kit. GD125 ramp.	£405.38
KX8538A	Mesh side kit. GD106 tailboard.	£434.75
KX8538	Mesh side kit. GD106 ramp.	£370.13
KX8540A	Mesh side kit. GD126 tailboard.	£481.75
KX8540	Mesh side kit. GD126 ramp.	£417.13



Ask our sales team about a canopy for your GD trailer!

To Order – See pages 4 & 5 for distributor contact details or call direct on 0845 4082 505

To Order – See pages 4 & 5 for distributor contact details or call direct on 0845 4082 505



P6e tailboard model



P7e ramp model

P6e & P7e DEDICATED KITS



KX8635 Mesh side kit P6e. Tailboard models, full mesh sides kit also includes mesh rear panel, mesh ladder rack & all mounting hardware required. **£252.63**



KX8636 Mesh side kit P6e. Ramp models, full mesh sides kit also includes mesh ladder rack & all mounting hardware required. **£211.50**



KX8638 Mesh side kit P7e. Tailboard models, full mesh sides kit also includes mesh rear panel, mesh ladder rack & all mounting hardware required. **£264.38**



KX8639 Mesh side kit P7e. Ramp models, full mesh sides kit also includes mesh ladder rack & all mounting hardware required. **£223.25**

P00355DB Standard P6e drawbar. Swan neck style drawbar with coupling attached. **£50.00**

P00355DB2 Standard P7e drawbar. Swan neck style drawbar with coupling attached. **£52.90**

P1388 Tarpaulin. Blue elasticated tarpaulin cover tailored to fit the P6e trailer (tailboard models only). **£58.75**

P1389 Tarpaulin. Blue elasticated tarpaulin cover tailored to fit the P7e trailer (tailboard models only). **£64.63**

KX830 Treadplate floor. Hardwearing aluminium floor for P6e. **£152.75**

KX8637 Treadplate floor. Hardwearing aluminium floor for P7e. **£123.38**

P6e & P7e COMMON ACCESSORIES



AS8217 Ladder rack. Open framed design simply slots into the front of P6e and P7e. **£41.13**



KS8510 Ramp kit. Replacement standard ramp - ideal for conversions from tailboard. **£99.90**



KS8509 Stock ramp. Replacement ramp with small stock door built in (reversible door). **£141.00**



KS0229 Tailboard. Complete tailboard assembly for P6e or P7e models. **£70.50**



AS8216 Tailboard frame. Galvanised tailboard frame for P6e or P7e. **£29.40**

KX0652 ATV drawbar. Longer straight drawbar to suit lower ATV couplings. **£23.50**

P0567 Jockey wheel. Simply replaces the existing front propstand. **£29.38**



C14444 Number plate panel. Formed steel panel only. **£9.00**

AS5106 Spare wheel carrier. For P6e & P7e with flotation or 145/70R13 tyres. **£14.10**

AS5107 Spare wheel carrier. For P6e with 145R10 tyres. **£14.10**

KX0630A Aluminium canopy door. Complete with safety glass for P6e & P7e canopies. **£105.75**

KX0630B Aluminium canopy door. Solid panel (no window) for P6e & P7e canopies. **£99.90**



P7e with KX8639 Mesh sides and KS8509 stock ramp





BV64e with AS4522 Roof rack



P5 with P1387 Tarpaulin cover

BV64e MINI BOXVAN



AS4522	Roof rack kit. Incorporates tie-down points for lashing the load (BV64e van door models only, max roof rack weight limit 30kg).	£47.00
KX0650	Treadplate floor. Hardwearing aluminium treadplate shaped to fit any BV64e.	£123.38
C81616	Rubber matting. Grippy rubber matting shaped to fit any BV64e.	£29.40
KX0651	Tie ring kit. Pair of internal tie rings (floor mounted, includes fixing bolts).	£11.75
P0567	Jockey wheel. Simply replaces the existing front propstand.	£29.38
AS5875	Propstand. Replacement galvanised propstand tube (priced each).	£10.05
C72160	Mudwing RH. Moulded plastic wheel arch/wing with cutout for rear lighting.	£35.25
C72161	Mudwing LH. Moulded plastic wheel arch/wing with cutout for rear lighting.	£35.25
C72162	Roof moulding. GRP Moulded roof as used on the roller shutter version.	£129.25
AS2466	RH rear door. Includes hinges, locking mechanism & exterior locking handle.	£146.90
AS2467	LH rear door. Includes hinges.	£146.90
P1055	Lock rods. Internal centre lock mechanism and upper/lower rod set.	£12.75



P5 RANGE

1	KX8612	Lamp guards. Pair of wire mesh guard to fit over the rear lamps.	£23.50
2	KX8613	Front propstand Kit. Includes stand, clamp & all mounting hardware required.	£18.80
	KX8614	Treadplate floor. Hardwearing aluminium treadplate tailored to fit the P5.	£70.50
3	KX8615	Jockey wheel kit. Includes jockey wheel, clamp & all mounting hardware.	£35.25
	KX8616	Ladder rack kit. Includes corner sockets & all mounting hardware required.	£41.13
	KX8626	Mesh ladder rack kit. Includes corner sockets & all mounting hardware.	£52.88
	KX8627	Mesh side kit. Tailboard models, Full mesh sides kit also includes mesh rear panel, mesh ladder rack, corner sockets & all mounting hardware required.	£176.25
	KX8628	Mesh side kit. Ramp models, Full mesh sides kit also includes mesh ladder rack, corner sockets & all mounting hardware required.	£158.63
	KS8610	Tailboard kit. P5 Tailboard assembly complete with hinge pins.	£47.00
	KS8611	Ramp kit. P5 Ramp assembly complete with hinge pins.	£94.00
	P1387	Tarpaulin. Blue elasticated tarpaulin cover (tailboard models only).	£47.00
4	P12451	Rope stud. Round plastic stud (rivet fixed, rivet not included).	£0.25
5	KX0652	ATV drawbar. Longer straight drawbar to suit lower ATV couplings.	£23.50

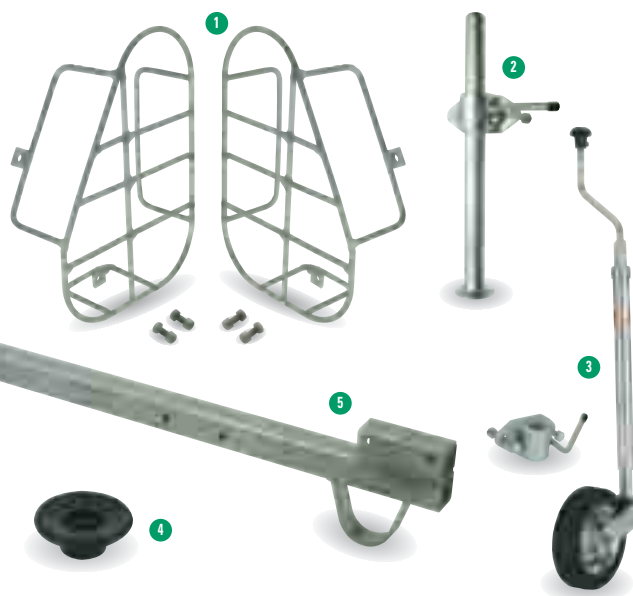

P5 With KX8628 Mesh side kit

CT177 Mk1 or Mk2?

The Mk1 trailers were beavertailed and had curved cutaways in the loading skids. Mk2 models are totally flat and have squarer skids.



CT177 with GM5 Heavy duty strap winch fitted

ACCESSORIES & OPTIONS

P0470	GM5 winch. High quality heavy duty strap winch with fast rewind action.	£693.25
P04701	GM5 winch. High quality heavy duty cable winch with fast rewind action.	£693.25
P04702	3T winch. Three tonne capacity strap winch.	£305.50
P04703	3T winch. Three tonne capacity cable winch.	£317.25
P04704	E40 electric winch. Supplied with jumper cable set.	£716.75
1 C11752	Winch mounting arm. Winch fitting section for CT177 Mk1 versions.	£11.75
2 AS3732	Winch slider bracket. Adjustable fixing for CT177.	£8.80
KX6155	Electric winch kit. With E40 electric winch, battery and mounting bracket (Not suitable for CT177 Mk2 versions when used with Ski-jump kit).	£869.50
3 KX5551	Winch mounting bracket. Adjustable tilting bracket for CT177 Mk2 versions.	£19.95
4 KX0241	Wheel chocks. Spring loaded clip-in wheel chocks (LH / RH pair).	£47.00

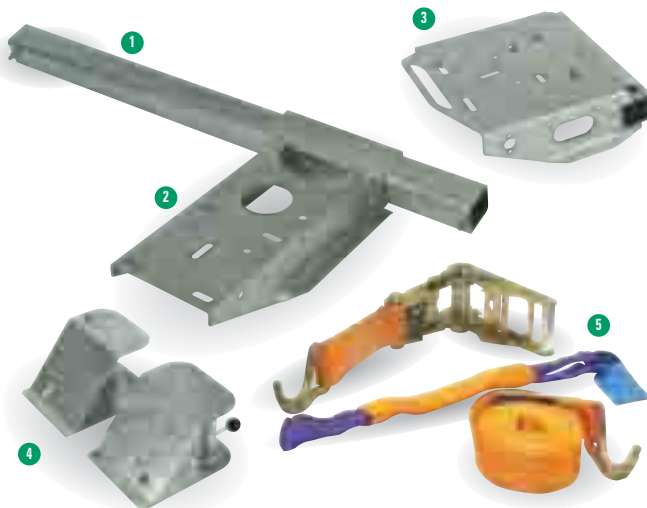

KX5550	Centre decking. Lightweight aluminium treadplate decking.	£205.63
KX5552	Ski-jump kit. Special loading skid set that allows loading of a larger vehicle over the front of the CT177 (CT177 Mk2 versions only).	£270.25
5 P1042	Wheel securing strap. Suitable for all models of CT177.	£18.21

UNIQUE SPARE PARTS

6 AS3723	Mini-skid assy LH. Pull out mini skid as fitted to CT177 Mk1 models.	£40.55
AS3724	Mini-skid assy RH. Pull out mini skid as fitted to CT177 Mk1 models.	£40.55
7 AS3729	Skid assembly. Pull out skid as fitted to CT177 Mk2 models (fits either side).	£70.50
AS3705	Drawbar set. Complete replacement weld assembly.	£346.65
KS3715	Rear Light assy RH. Includes mounting bracket.	£29.40
KS3716	Rear Light assy LH. Includes mounting bracket.	£29.40
8 KS3722	Toolbox & spare wheel mounting. Suitable for all models of CT177.	£52.90
C11736	Toolbox lid. Suitable for all models of CT177.	£11.75
C11707	Number plate mount. Pressed steel panel as fitted to CT177 Mk1 models.	£7.65
C11746	Number plate mount. Pressed steel panel as fitted to CT177 Mk2 models.	£7.35
P1087	Body clamp. Over centre clamp secures body to drawbar.	£29.40
AS3713	Hook & plate. For over centre body clamp.	£4.40
P1086	Toolbox clamp. Small over centre clamp secures toolbox lid.	£2.40
P1086B	Receiver plate. For small over centre clamp.	£0.60
C01700	Drawbar pivot bush. Priced each.	£1.55
C01705	Drawbar pivot bolt. Specially shaped M24 bolt unique to the CT177.	£6.95
F1066Z	M24 nut. To suit drawbar pivot bolt.	£0.95
C01706	Jockey wheel clamp handle. Longer version unique to CT177.	£3.50
F0380Z	Spare wheel fitting bolt. Long M12 bolt fitted through wheel into well.	£1.45
C70694	Spare wheel fitting washer. Shaped nylon washer fitted under long M12 bolt.	£0.40

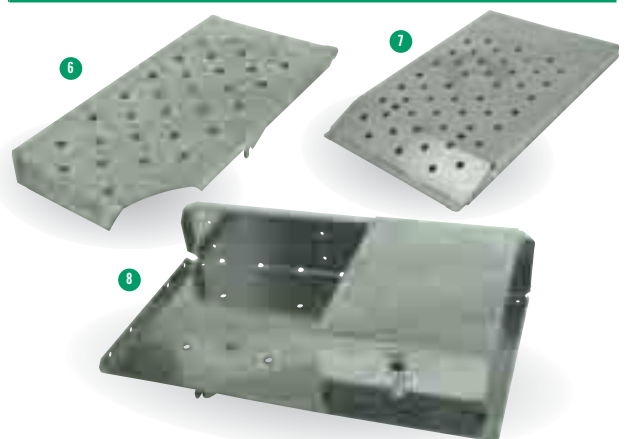

To Order – See pages 4 & 5 for distributor contact details or call direct on 0845 4082 505

Model Specific

CT136 Car Transporter



CT136 Twin axle model

To Order – See pages 4 & 5 for distributor contact details or call direct on 0845 4082 505

ACCESSORIES & OPTIONS

P04705	Winch "Circuit". 600Kg rated mechanical cable winch.	£105.75
P04706	Winch "Rally". 1050Kg rated mechanical cable winch.	£158.63
P04707	Winch "Recovery". 1500Kg rated mechanical cable winch.	£188.00
1 KX5531	Winch mounting kit. Allows the winch to be used on either side of the drawbar (Single or twin axle trailer, not suitable for CT136 Heavy Duty model).	£58.75
KX5528	Winch mounting kit. CT136 Heavy duty model only.	£64.65

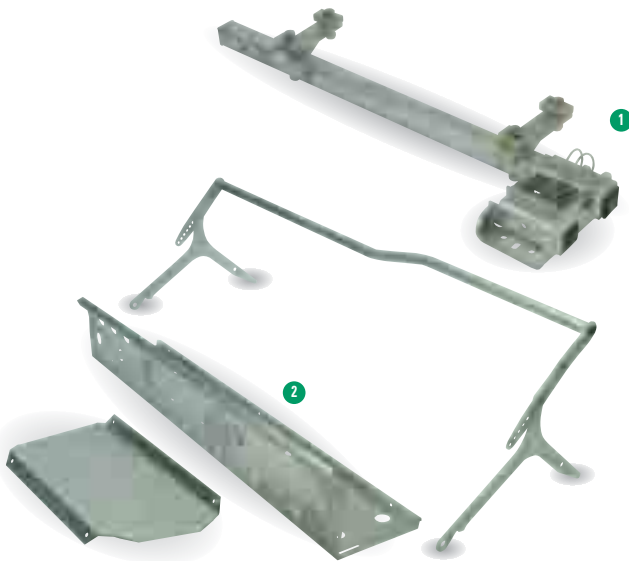

2 KX5532	Tyre rack cranked bar. For carrying different size tyre sets (Single or twin axle trailer, not suitable for CT136 Heavy Duty model).	£105.75
KX5533	Tyre rack straight bar. For carrying tyres that are all the same size (Single or twin axle trailer, not suitable for CT136 Heavy Duty model).	£105.75
KX5534	HD tyre rack cranked bar. For carrying different size tyre sets (CT136 Heavy Duty model only).	£123.40
KX5535	HD tyre rack straight bar. For carrying tyres that are all the same size (CT136 Heavy Duty model only).	£123.40
KX5530	Motorcycle carrier kit. (CT136 Twin axle & Heavy Duty models).	£105.75
P1042	Wheel securing strap. Suitable for all models of CT136.	£18.21
KX0242	Wheel chocks. Slide-in front wheel chocks (LH / RH pair inc. fasteners).	£41.13
KX0243	Spare wheel kit. For all models of CT136 includes tyre, wheel and bracket.	£99.88
3 KX0235	Toolbox kit. Suitable for all models of CT136.	£52.88

UNIQUE SPARE PARTS

4 C11826	Loading skid LH. Replacement loading skid (not CT136 Heavy Duty model).	£47.00
C11852	Loading skid RH. Replacement loading skid (not CT136 Heavy Duty model).	£47.00
C11862	HD loading skid RH. Replacement loading skid for CT136 Heavy Duty models.	£35.25
C11863	HD loading skid LH. Replacement loading skid for CT136 Heavy Duty models.	£35.25
5 C74810	Skid stop. Plastic stop fitted to end of skid pressing and trailer bed.	£0.90



C11845	Number plate panel. Fold down number plate/skid flap (not CT136 Heavy Duty).	£9.75
C11864	HD number plate panel. Fold down number plate/skid flap (CT136 Heavy Duty).	£12.00
C01117	Number plate retainer. long lynch pin receiver for number plate/skid flap.	£3.75
C11828	Light bracket RH. Also acts as RH crossmember support (Lamp not included).	£22.90
C11814	Light bracket LH. Also acts as RH crossmember support (Lamp not included).	£22.90
P0603	Mudguard. Single arch plastic mudguard (Single or twin axle trailer).	£16.95
P1086	Toolbox clamp. Small over centre clamp secures toolbox lid.	£2.40
P1086B	Receiver plate. For small over centre clamp.	£0.60
C11848	Toolbox lid. Pressed steel panel only.	£11.75

To Order – See pages 4 & 5 for distributor contact details or call direct on 0845 4082 505



	P1200	Roller shutter. Roller shutter kit for BV5 series (6' headroom). £251.45
	P12011	Roller shutter. Roller shutter kit for BV6 series (7' headroom). £378.35
	C69603	Boxvan side sheet. 1678 x 718 x 14mm GRP smooth faced sheet. £86.85
	C69602	Boxvan side sheet. 1829 x 870 x 14mm GRP smooth faced sheet. £103.25
	C69611	Boxvan side sheet. 2134 x 1010 x 14mm GRP smooth faced sheet. £113.50
	C10208	Rear panel. BV126 - rear upper panel (over the roller shutter door). £30.90
1	P12453	Slam latch. Fitted inside the left hand rear door on the BV84 boxvan trailer, adjustable latching point. £4.70
	P1053	Handle. Locking handle with 180 degree movement between open and closed, 8mm square operating shaft. £21.75
2	P1054	Handle. Lever handle used on various boxvan models. £21.75
3	P10580	Handle. Push button handle used on BV84 inspection doors. £21.75
4	P1059	Latch. RH door latch mechanism as used on boxvans with front door located on left hand side. £21.45
	P1060	Latch. LH door latch mechanism as used on boxvans with front door located on right hand side. £21.45

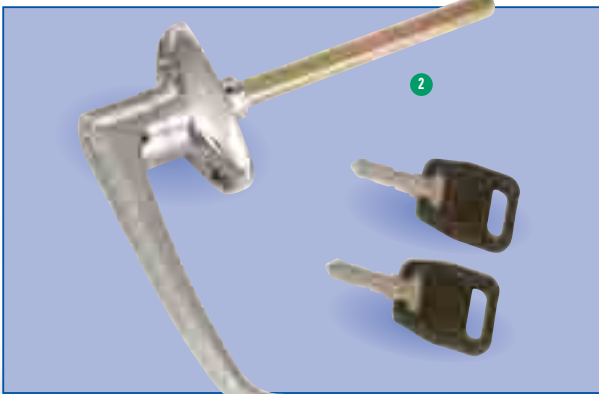











EL101-2012 With Aluminium dropsides and ladder rack fitted

DROPSIDES, HEADBOARDS & FLOORS

	KX3000 Aluminium dropside kit. Dropsides & pillars for EL101-2012.	£411.25
	KX3020 Aluminium dropside kit. Dropsides & pillars for EL101-2512 & EL142-2512.	£423.00
	KX3030 Aluminium dropside kit. Dropsides & pillars for EL101-2515, EL141-2515, EL142-2515 & EX202-2515.	£452.38
	KX3050 Aluminium dropside kit. Dropsides & pillars for EL142-3015 & EX202-3015.	£511.13
	KX3060 Aluminium dropside kit. Dropsides & pillars for EL142-3615 & EX202-3615.	£552.25
	KX3100 Steel dropside kit. Dropsides & pillars for EL101-2012.	£164.50
	KX3120 Steel dropside kit. Dropsides & pillars for EL101-2512 & EL142-2512.	£170.38
	KX3130 Steel dropside kit. Dropsides & pillars for EL101-2515, EL141-2515, EL142-2515 & EX202-2515.	£176.25
	KX3150 Steel dropside kit. Dropsides & pillars for EL142-3015 & EX202-3015.	£223.25
	KX3160 Steel dropside kit. Dropsides & pillars for EL142-3615 & EX202-3615.	£235.00
	KX3090 Aluminium headboard kit. For all 1.2m wide eurolight models.	£146.88
	KX3091 Aluminium headboard kit. For all 1.5m wide eurolight models.	£158.63
	KX3095 Steel headboard kit. For all 1.2m wide eurolight models.	£64.63
	KX3096 Steel headboard kit. For all 1.5m wide eurolight models.	£70.50
	KX3240 Ladder rack kit. For all 1.2m wide eurolight models.	£41.13
	KX3250 Ladder rack kit. For all 1.5m wide eurolight models.	£47.00
	KX3380 Aluminium treadplate floor kit. For EL101-2012.	£129.25
	KX3382 Aluminium treadplate floor kit. For EL101-2512 & EL142-2512.	£158.63
	KX3384 Aluminium treadplate floor kit. For EL101-2515, EL141-2515, EL142-2515 & EX202-2515.	£193.88
	KX3386 Aluminium treadplate floor kit. For EL142-3015 & EX202-3015.	£229.13
	KX3388 Aluminium treadplate floor kit. For EL142-3615 & EX202-3615.	£270.25
	1 KX3185 Propstand kit. Pair - for all eurolight models.	£52.88
	KX3190 Lashing ring kit. Pair - for all eurolight models.	£23.50
	2 KX3192 Rope hook kit. Pair - extra pair of ropehooks for all eurolight models.	£2.70

MESH SIDES & SKIDS

	KX3350 Mesh side kit. Includes all fittings for EL101-2012.	£270.25
	KX3352 Mesh side kit. Includes all fittings for EL101-2512 & EL142-2512.	£317.25
	KX3362 Mesh side kit. Includes all fittings for EL101-2515, EL141-2515, EL142-2515 & EX202-2515.	£364.25
	KX3364 Mesh side kit. Includes all fittings for EL142-3015 & EX202-3015.	£411.25
	KX3366 Mesh side kit. Includes all fittings for EL142-3615 & EX202-3615.	£458.25
	KX3200 Skid stowage kit A. For EL101-2012, EL142-2012, EL142-2515 & EX202-2515.	£35.25
	KX3210 Skid stowage kit B. For EL101-2512, EL101-2515, EL141-2515, EL142-3015, EL142-3615, EX202-3015 & EX202-3615.	£35.25
	3 KX3180 2.0m loading skid. Pair - for all eurolight models (where skid stowage kit fitted).	£88.13



To Order – See pages 4 & 5 for distributor contact details or call direct on 0845 4082 505



FOR MANUAL PUMP

1	P11305	Pump. Hand pump used on Tipping trailer TT85.	£152.75
2	P11415	Pump. Hand pump used on Tilt-bed trailers CT166 and CT167.	£152.75
	P11415H	Pump handle. For the TT85 tipper trailer (manual pump).	£19.04
3	P11308	Filler cap. For both hand pumps.	£9.65
	P11309	Release valve. For both hand pumps.	£22.90

HOSES

	P11330	Hydraulic hose. 3/8 BSP x 0.99M long.	£15.85
	P11339	Hydraulic hose. Fits between the pump unit and the Ram on TT126 trailers.	£15.85
	P11334	Hydraulic fitting kit. All the connectors, elbows and rubber bonded washers used on TT85 (manual pump).	£2.60



4	P1131	Hydraulic Ram. Hydraulic lifting ram for TT85 Tipping trailers.	£188.00
5	P11310	Hydraulic Ram. Hydraulic lifting ram for TT105 Tipping trailers.	£334.90
6	P1139	Hydraulic Ram. For the CT166 and CT167 models (2 required per trailer).	£115.75
7	P11317	Hydraulic Ram. For the CT177 model.	£211.50
8	P1143/I	Flow control (Anti-burst) valve. Fitted within hydraulic rams.	£21.70
9	P11311	Seal kit. For TT105 hydraulic ram. (P11310)	£34.50
	P11312	Seal kit. For TT85 hydraulic ram (P1131).	£34.52



TT126 with optional ladder rack & Land Rover defender fitted with V383 Canopy

Model Specific - Tipper

Hydraulic Power Pack

To Order – See pages 4 & 5 for distributor contact details or call direct on 0845 4082 505



SPARES FOR FENNER/SPX HYDRAULIC POWER PACKS

1	P11972	Controller. Hand controller and weatherproof plug.	£69.35
2	P119714	Solenoid. For the Fenner / SPX Hydraulic power units.	£45.85
3	P119722	Pump handle. For the manual pump section.	£15.85
4	P119715	Release Solenoid. For the release valve.	£29.40
5	P1244	End plug. Round blanking plug.	£0.30
6	P119724	Manual release screw. Including seal.	£25.25
7	P119716	Hand pump cartridge. For the manual pump section.	£129.25
8	P119713	Filler cap. Incorporating breather.	£5.00
9	P0670	Isolator switch. Battery isolator switch supplied with one removable key.	£10.55
10	P07255	Aqua safe plug and socket. Waterproof plug and socket used for the interior lamp connector on DP trailers and the handset connection on tippers.	£12.35
11	P0670A	Isolator key. Spare key for isolator switch.	£4.50
	P119712	Tank. Plastic Reservoir for the Fenner/SPX Hydraulic.	£54.05
	P119710	Motor. Replacement motor.	£163.35



12	P11974	Hydraulic power pack FG515 12v	£450.00
13	P11974BC	Battery cables	£28.00
14	P11974SF	Suction filter	£8.35
15	P11974DD	Drive dog	£6.90
16	P11974EP	3-Pin handset plug	£6.00
17	P11974ES	3-Pin handset socket	£6.15
18	P11974FC	Filler cap	£5.00
19	P11974H	Pump handle	£15.85
20	P11974HH	Hydraulic hose	£17.90
21	P11974HS	Handset & lead	£55.70
22	P11974LB	Lever base kit	£14.45
23	P11974LC	Coil for lowering valve	£29.40
24	P11974LV	Lowering valve complete	£66.05
25	P11974LVNC	Lowering valve body (no coil fitted)	£36.65
26	P11974M	Motor	£150.00
27	P11974MC	Motor cover	£19.75
28	P11974MV	Manual lowering valve	£18.00
29	P11974P	Pump kit	£58.40
30	P11974SC	Seal kit (o rings)	£28.00
31	P11974SS	Start solenoid	£25.00
32	P11974T	Tank kit	£52.95



To Order – See pages 4 & 5 for distributor contact details or call direct on 0845 4082 505

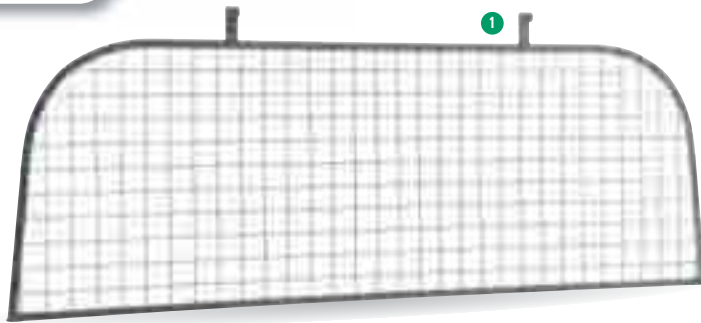

Aluminium door option seen here on V381A

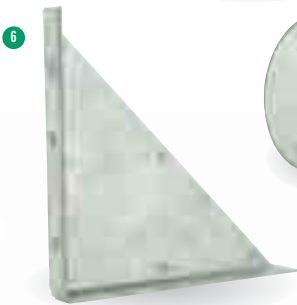
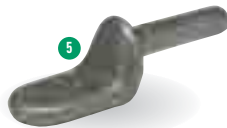

1	AS1040	Tailgate. Mesh tailgate for Landrover Hi-Capacity canopy.	£41.15
	AS1050	Tailgate. Mesh tailgate for Landrover canopy.	£41.15
	AS1125	Tailgate. Mesh tailgate for Bedford Brava canopy (May 1997 >).	£41.15
	AS1130	Tailgate. Mesh tailgate for Peugeot 504 canopy.	£41.15
	AS1140	Tailgate. Mesh tailgate for Toyota Mk3 canopy.	£41.15
	AS1180	Tailgate. Mesh tailgate for Nissan canopy.	£41.15
	AS1200	Tailgate. P6e - Mesh tailgate for trailer fitted with canopy and a tailboard.	£41.15
2	KX0381A	Tailgate. Landrover 100 - Aluminium rear door with window.	£105.75
	KX0383A	Tailgate. Landrover 90 - Aluminium rear door with window.	£105.75
	KX0402A	Tailgate. Mitsubishi Mk2 - Aluminium rear door with window.	£105.75
	KX0460A	Tailgate. Toyota MK2 - Aluminium rear door with window.	£105.75
	KX0462A	Tailgate. Toyota Mk3 - Aluminium rear door with window.	£105.75
	KX0470A	Tailgate. VW Caddy - Aluminium rear door with window.	£105.75
	KX0630A	Tailgate. P6e - Aluminium panelled tailgate incorporating window (for trailer fitted with canopy and a tailboard).	£105.75
	P1004	Antiluce. Used on HB306 & 407, HB505 (to december 1991) and on horsebox containers.	£2.35
	P1021	Retainer hook. Used to hold the centre partition open whilst loading.	£1.70
3	P1023	Cable clip. Fits into a pre-drilled hole and accepts up to 8mm round cable, many other uses.	£0.60
4	P1051	Grab handle. As fitted to aluminium doors.	£3.75
5	P1101B	Gudgeon. Weld on component used in canopy tailgates and formerly used on painted livestock trailer inspection doors.	£3.55
	AS5094	Propstand. Prop assembly for rear aluminium doors.	£7.05
	C00898	Canopy fixing. Bracket used on many pick-up canopies.	£1.20
6	C11480	Gusset. Used to strengthen rear corners of canopy.	£3.05
7	C11899G	Antiluce plate. Used on most canopy tailgates.	£1.50
	C14737	Rampgate bracket. P6e RH upper rampgate support bracket fits inside canopy.	£4.05
	C14738	Rampgate bracket. P6e LH upper rampgate support bracket fits inside canopy.	£4.05
	C49878	Canopy Z rail. 3962mm canopy outer rail "Z" section extrusion (requires rubber insert).	£19.75
8	F1401	Hook bolt. M8 x 60mm used in a variety of applications.	£0.40
	F1402	Hook bolt. M8 x 70mm used in a variety of applications.	£0.50
	F1404	Hook bolt. M8 x 90mm used in a variety of applications.	£0.55
	F1409	Hook bolt. M8 x 140mm used in a variety of applications.	£0.65
	KS1120	Canopy kit. Assorted fasteners, enough to fit one canopy to most types of vehicle.	£4.70
9	P1229	Spring bolt receiver. Used within P6e/7e livestock canopies to secure cross divisions.	£0.85

Adding a canopy to an open trailer such as a P6e will greatly increase its versatility, however if you wish to use it for livestock you will also need ramp side gates and possibly cross divisions too. Our sales department will be happy to advise on canopies to fit your trailer or pickup.